

工程名稱

HILTI HIT-RE 500 V3 化學錨栓工程
品質管理與施工計畫書

材料廠商：喜利得股份有限公司

中 華 民 國

目 錄

- 一、 說明
- 二、 品質管理及拉拔試驗
 - (一) 品質管理
 - (二) 錨栓施工前或施工後拉拔試驗
- 三、 材料
 - (一) 化學黏著藥劑
- 四、 施工步驟
 - (一) 鑽孔
 - (二) 化學錨栓安裝
- 五、 附件說明

施工說明

一、 說明

本工程施工要點乃在原有結構之混凝土上鑽孔，注入化學黏著藥劑並旋入鋼筋或螺桿，以達到鋼筋或螺桿與原有結構混凝土結成一體之目的，增加設計之彈性，以達到新舊結構物結合之目的。

二、 品質管理及拉拔試驗

必要的品質管制與測試機制，可使得工程進展順利，更可以維持工程的品質，保障大眾權益，本化學藥劑品質管理及拉拔試驗均依據規範辦理。

(一) 品質管理

- A. 本植筋及化學錨栓工程使用之化學藥劑為 HILTI HIT-RE500 V3，其使用期限標示於藥劑瓶蓋上。植筋施作前需注意藥劑是否在使用期限之內，逾期不得使用，並提供藥劑之購買與進口證明予工地工程司查核。
- B. 本化學藥劑 HILTI HIT-RE500 V3 依照製造廠商之產品安全資料)儲存方式保管，工地現場需放置於陰涼處所避免陽光直接照射，其產品安全資料需標明誤觸或誤食之處理方式，使用藥劑前施工人員應穿戴護目鏡及手套等防護措施。
- C. 本化學藥劑通過美國規範協會 ICC AC308 之認證報告，報告編號為 ICC ESR-3814(詳附件一)，其通過之測試項目詳報告中第 5 及 4 章節所述，內容包含通過潛變試驗(第 5.6 節 long-term loads ; AC308 第 7 項試驗)、潮濕試驗(第 4.1.4 節 water-saturated ; AC308 第 2f 項試驗)、耐震試驗(第 5.7 節 seismic design ; AC308 第 17、18 項試驗)、握裹性測試(第 4.1.4 節 bond strength determination ; AC308 第 1、11、16 項試驗)，本化學藥劑之耐震測試結果

喜利得股份有限公司

送審專用

FOR REVIEW

符合 IBC 或 IRC 規定之地震設計類別(Seismic Design Category : C, D, E 或 F)以及 UBC 規定之地震區域(Seismic Zone : 2B, 3, 4)。AC308 測試項目如 ESR-3814 後附件所述。其中 ICC AC308 之認證報告中,符合實驗標準 **ASTM E 488-96** 於允收標準第 1.3.22 節中說明為『ASTM E 488-96(2003), Standard Test Method for Strength of Anchors in Concrete and Masonry Elements, ASTM International.』如附件一第二頁。

- D. 拉拔試驗之試驗單位與儀器依規範辦理,詳細規定如下:
- a. 油壓千斤頂及手動幫浦,需提供財團法人全國認證基金會(TAF)或經濟部標準檢驗局認可之實驗單位或經濟部標準檢驗局認證通過之校正期限為一年內之校正報告。

(二) 植筋及化學錨栓施工前或施工後拉拔試驗

- A. 設備:油壓千斤頂、手動幫浦、校正報告、夾具等。植筋試驗以同尺寸高拉力螺桿(CNS 3934 8.8 級)以不小於1.0倍鋼筋降伏拉力,化學錨栓以不小於1.0倍設計拉力為測試力量並,依規範要求之拉力在不同混凝土強度作測試(藥劑錨錠不可破壞),並紀錄孔深、使用藥劑品牌及型號。
- B. 試驗時,確定其樣本周圍表面平坦且與鋼筋垂直,以做為千斤頂施力時之反力。
- C. 將夾具固定再受測樣本上,再套入千斤頂並裝上夾具。測試時可依據實際情形,裝置腳座以方便測試進行。
- D. 將手動幫浦油壓管接上千斤頂,並旋緊閥門。
- E. 確定油壓錶歸零後由手動幫浦慢慢加壓,直到油壓錶達到試驗拉力所需值。
- F. 記錄並拍照存證後打開閥門,解除壓力,試驗完竣。

驍利得股份有限公司
送審專用
FOR REVIEW

三、 材料

(一) 化學黏著藥劑

本化學藥劑為二劑型藥劑(主劑及硬化劑)，並符合規範規定，通過 ICC AC308 規範之握裹性、潛變、耐震及潮濕環境測試，ICC AC308 允收標準報告詳**附件一**， HILTI HIT-RE500 V 3 產品型錄詳**附件二**。

四、 施工步驟

(一) 鑽孔

1. 本藥劑進場經核可後方可使用。
2. 鑽孔應按照預定之順序及位置，使用電鎚鑽，連續鑽孔須達到規定之直徑、深度及角度。
3. 施工時於鑽孔過程中，如遇鋼筋及未達設計孔深而遇到既有鋼筋時，則此鑽孔予以廢棄不用，另行鑽孔，而廢孔以無收縮水泥砂漿填實。
4. 鑽孔完畢後用吹氣筒或其他空壓設備將孔內灰屑吹出。

(二) 化學植筋或化學錨栓安裝

1. 將本化學藥劑裝入注射器中，再將混合器安裝完成。若鑽孔深度超過混合器長度時，可加裝延長管(內附)使用。(使用新的藥劑包需廢棄前2~3次扣板機所流出的藥劑，以確保藥劑有充分混合)
2. 注射時深入孔底緩緩將化學藥劑打入孔內，依刻度邊打邊退，直到注入至少六分滿為止，再將準備好之鋼筋慢慢旋入孔內，直至底部且可目視藥劑外溢。
3. 化學植筋及錨栓施作完成後，應靜置避免擾動，待超過藥劑膠凝時間，即可硬化完成進行負載或施工。
4. 待施工完成後，必須經業主或監造人員檢驗合格，完成記錄備核。

喜利得股份有限公司

送審專用

FOR REVIEW

五、 附件說明

- (一) HILTI HIT-RE500 V3 ICC 認證報告
 - 通過 ICC AC308 允收標準報告：ESR-3814
- (二) HILTI HIT-RE500 V3 原廠型錄
- (三) 材料廠商公司資料
- (四) HILTI HIT-RE500 V3 TAF 試驗報告
 - 黏著強度 ASTM C882/C882M-13a
 - 吸水率 ASTM D570-98(2010)e1
 - 接著強度 CNS 1010142 (1994)
 - 抗壓強度 CNS 1010142 (1994)
- (二) HILTI HIT-RE500 V3 防腐蝕報告
- (三) ASTM E1512及E488 規範

附件一 HILTI HIT-RE500 V3 長期潛變報告

-通過 ICC AC308 允收標準報告

ESR-3814

DIVISION: 03 00 00—CONCRETE
Section: 03 16 00—Concrete Anchors

DIVISION: 05 00 00—METALS
Section: 05 05 19—Post-installed Concrete Anchors

REPORT HOLDER:

HILTI, INC.

EVALUATION SUBJECT:

HILTI HIT-RE 500 V3 ADHESIVE ANCHORS AND POST-INSTALLED REINFORCING BAR CONNECTIONS IN CRACKED AND UNCRACKED CONCRETE

1.0 EVALUATION SCOPE

Compliance with the following codes:

- 2018, 2015, 2012 and 2009 *International Building Code*® (IBC)
- 2018, 2015, 2012 and 2009 *International Residential Code*® (IRC)
- 2013 *Abu Dhabi International Building Code* (ADIBC)[†]

[†]The ADIBC is based on the 2009 IBC. 2009 IBC code sections referenced in this report are the same sections in ADIBC.

For evaluation for compliance with the *National Building Code of Canada*® (NBCC), see listing report [ELC-3814](#).

For evaluation for compliance with codes adopted by Los Angeles Department of Building and Safety (LADBS), see [ESR-3814 LABC and LARC Supplement](#).

Property evaluated:

Structural

2.0 USES

The Hilti HIT-RE 500 V3 Adhesive Anchoring System and Post-Installed Reinforcing Bar System are used to resist static, wind and earthquake (Seismic Design Categories A through F) tension and shear loads in cracked and uncracked normal-weight concrete having a specified compressive strength, f'_c , of 2,500 psi to 8,500 psi (17.2 MPa to 58.6 MPa) [minimum of 24 MPa is required under ADIBC Appendix L, Section 5.1.1].

The anchor system complies with anchors as described in Section 1901.3 of the 2018 and 2015 IBC, Section 1909 of the 2012 IBC and is an alternative to cast-in-place anchors described in Section 1908 of the 2012 IBC, and Sections 1911 and 1912 of the 2009 IBC. The anchor systems may

also be used where an engineered design is submitted in accordance with Section R301.1.3 of the IRC.

The post-installed reinforcing bar system is an alternative to cast-in-place reinforcing bars governed by ACI 318 and IBC Chapter 19.

3.0 DESCRIPTION

3.1 General:

The Hilti HIT-RE 500 V3 Adhesive Anchoring System and Post-Installed Reinforcing Bar System are comprised of the following components:

- Hilti HIT-RE 500 V3 adhesive packaged in foil packs
- Adhesive mixing and dispensing equipment
- Equipment for hole cleaning and adhesive injection

The Hilti HIT-RE 500 V3 Adhesive Anchoring System may be used with continuously threaded rod, Hilti HIS-(R)N internally threaded inserts or deformed steel reinforcing bars as depicted in Figure 4. The Hilti HIT-RE 500 V3 Post-Installed Reinforcing Bar System may only be used with deformed steel reinforcing bars as depicted in Figures 2 and 3. The primary components of the Hilti Adhesive Anchoring and Post-Installed Reinforcing Bar Systems, including the Hilti HIT-RE 500 V3 Adhesive, HIT-RE-M static mixing nozzle and steel anchoring elements, are shown in Figure 6 of this report.

The manufacturer's printed Installation instructions (MPII), as included with each adhesive unit package, are consolidated as Figure 9A and 9B.

3.2 Materials:

3.2.1 Hilti HIT-RE 500 V3 Adhesive: Hilti HIT-RE 500 V3 Adhesive is an injectable, two-component epoxy adhesive. The two components are separated by means of a dual-cylinder foil pack attached to a manifold. The two components combine and react when dispensed through a static mixing nozzle attached to the manifold. Hilti HIT-RE 500 V3 is available in 11.1-ounce (330 ml), 16.9-ounce (500 ml), and 47.3-ounce (1400 ml) foil packs. The manifold attached to each foil pack is stamped with the adhesive expiration date. The shelf life, as indicated by the expiration date, applies to an unopened foil pack stored in a dry, dark environment and in accordance with Figure 9A.

3.2.2 Hole Cleaning Equipment:

3.2.2.1 Standard Equipment: Standard hole cleaning equipment, comprised of steel wire brushes and nozzles, is described in Figure 9A of this report.



3.2.2.2 Hilti Safe-Set™ System: For the elements described in Sections 3.2.5.1 through 3.2.5.3 and Section 3.2.6, the Hilti TE-CD or TE-YD hollow carbide drill bit with a carbide drilling head conforming to ANSI B212.15 must be used. When used in conjunction with a Hilti vacuum with a minimum value for the maximum volumetric flow rate of 129 CFM (61 ℓ/s), the Hilti TE-CD or TE-YD drill bit will remove the drilling dust, automatically cleaning the hole. Available sizes for Hilti TE-CD or TE-YD drill bit are shown in Figure 9A.

3.2.3 Hole Preparation Equipment:

3.2.3.1 Hilti Safe-Set™ System: TE-YRT Roughening Tool: For the elements described in Sections 3.2.5.1 through 3.2.5.3 and Tables 9, 12, 17, 20, and 29, the Hilti TE-YRT roughening tool with a carbide roughening head is used for hole preparation in conjunction with holes core drilled with a diamond core bit as illustrated in Figure 5.

3.2.4 Dispensers: Hilti HIT-RE 500 V3 must be dispensed with manual, electric, or pneumatic dispensers provided by Hilti.

3.2.5 Anchor Elements:

3.2.5.1 Threaded Steel Rods: Threaded steel rods must be clean, continuously threaded rods (all-thread) in diameters as described in Tables 6 and 14 and Figure 4 of this report. Steel design information for common grades of threaded rods is provided in Table 2. Carbon steel threaded rods must be furnished with a 0.0002-inch-thick (0.005 mm) zinc electroplated coating complying with ASTM B633 SC 1 or must be hot-dipped galvanized complying with ASTM A153, Class C or D. Stainless steel threaded rods must comply with ASTM F593 or ISO 3506 A4. Threaded steel rods must be straight and free of indentations or other defects along their length. The ends may be stamped with identifying marks and the embedded end may be blunt cut or cut on the bias to a chisel point.

3.2.5.2 Steel Reinforcing Bars for use in Post-Installed Anchor Applications: Steel reinforcing bars are deformed bars as described in Table 3 of this report. Tables 6, 14, and 22 and Figure 4 summarize reinforcing bar size ranges. The embedded portions of reinforcing bars must be straight, and free of mill scale, rust, mud, oil, and other coatings (other than zinc) that may impair the bond with the adhesive. Reinforcing bars must not be bent after installation, except as set forth in ACI 318-14 26.6.3.1(b) or ACI 318-11 7.3.2, as applicable, with the additional condition that the bars must be bent cold, and heating of reinforcing bars to facilitate field bending is not permitted.

3.2.5.3 Hilti HIS-N and HIS-RN Inserts: Hilti HIS-N and HIS-RN inserts have a profile on the external surface and are internally threaded. Mechanical properties for Hilti HIS-N and HIS-RN inserts are provided in Table 4. The inserts are available in diameters and lengths as shown in Table 26 and Figure 4. Hilti HIS-N inserts are produced from carbon steel and furnished with a 0.0002-inch-thick (0.005 mm) zinc electroplated coating complying with ASTM B633 SC 1. The stainless steel Hilti HIS-RN inserts are fabricated from X5CrNiMo17122 K700 steel conforming to DIN 17440. Specifications for common bolt types that may be used in conjunction with Hilti HIS-N and HIS-RN inserts are provided in Table 5. Bolt grade and material type (carbon, stainless) must be matched to the insert. Strength reduction factors, ϕ , corresponding to brittle steel elements must be used for Hilti HIS-N and HIS-RN inserts.

3.2.5.4 Ductility: In accordance with ACI 318-14 2.3 or ACI 318-11 D.1, as applicable, in order for a steel element to be considered ductile, the tested elongation must be at

least 14 percent and reduction of area must be at least 30 percent. Steel elements with a tested elongation of less than 14 percent or a reduction of area of less than 30 percent, or both, are considered brittle. Values for various steel materials are provided in Tables 2, 3, 4, and 5 of this report. Where values are nonconforming or unstated, the steel must be considered brittle.

3.2.6 Steel Reinforcing Bars for Use in Post-Installed Reinforcing Bar Connections: Steel reinforcing bars used in post-installed reinforcing bar connections are deformed bars (rebar) as depicted in Figures 2 and 3. Tables 31, 32, 33, and Figure 4 summarize reinforcing bar size ranges. The embedded portions of reinforcing bars must be straight, and free of mill scale, rust, mud, oil, and other coatings that may impair the bond with the adhesive. Reinforcing bars must not be bent after installation, except as set forth in ACI 318-14 26.6.3.1(b) or ACI 318-11 7.3.2, as applicable, with the additional condition that the bars must be bent cold, and heating of reinforcing bars to facilitate field bending is not permitted.

3.3 Concrete:

Normal-weight concrete must comply with Sections 1903 and 1905 of the IBC, as applicable. The specified compressive strength of the concrete must be from 2,500 psi to 8,500 psi (17.2 MPa to 58.6 MPa) [minimum 24 MPa required under ADIBC Appendix L, Section 5.1.1].

4.0 DESIGN AND INSTALLATION

4.1 Strength Design of Post-Installed Anchors:

Refer to Table 1 for the design parameters for specific installed elements, and refer to Figure 5 and Section 4.1.4 for a flowchart to determine the applicable design bond strength or pullout strength.

4.1.1 General: The design strength of anchors complying with the 2018 and 2015 IBC, as well as Section R301.1.3 of the 2018 and 2015 IRC must be determined in accordance with ACI 318-14 Chapter 17 and this report.

The design strength of anchors under the 2012 and 2009 IBC, as well as the 2012 and 2009 IRC must be determined in accordance with ACI 318-11 and this report.

A design example according to the 2018 and 2015 IBC based on ACI 318-14 is given in Figure 7 of this report.

Design parameters are based on ACI 318-14 for use with the 2018 and 2015 IBC, and ACI 318-11 for use with the 2012 and 2009 IBC unless noted otherwise in Sections 4.1.1 through 4.1.11 of this report.

The strength design of anchors must comply with ACI 318-14 17.3.1 or ACI 318-11 D.4.1 as applicable, except as required in ACI 318-14 17.2.3 or ACI 318-11 D.3.3, as applicable.

Design parameters are provided in Table 6A through Table 30. Strength reduction factors, ϕ , as given in ACI 318-14 17.3.3 or ACI 318-11 D.4.3, as applicable, must be used for load combinations calculated in accordance with Section 1605.2 of the IBC or ACI 318-14 5.3 or ACI 318-11 9.2, as applicable. Strength reduction factors, ϕ , as given in ACI 318-11 D.4.4 must be used for load combinations calculated in accordance with ACI 318-11 Appendix C.

4.1.2 Static Steel Strength in Tension: The nominal static steel strength of a single anchor in accordance with ACI 318-14 17.4.1.2 or ACI 318-11 Section D.5.1.2, as applicable, and the associated strength reduction factors, ϕ , in accordance with ACI 318-14 17.3.3 or ACI 318-11 Section D.4.3, as applicable, are provided in the tables outlined in Table 1 for the anchor element types included in this report.

奥创智股份有限公司
送审专用
FOR REVIEW

4.1.3 Static Concrete Breakout Strength in Tension:

The nominal concrete breakout strength of a single anchor or group of anchors in tension, N_{cb} or N_{cbg} , must be calculated in accordance with ACI 318-14 17.4.2 or ACI 318-11 D.5.2, as applicable, with the following addition:

The basic concrete breakout strength of a single anchor in tension, N_b , must be calculated in accordance with ACI 318-14 17.4.2.2 or ACI 318-11 D.5.2.2, as applicable using the values of $K_{c,cr}$, and $K_{c,uncr}$, as described in this report. Where analysis indicates no cracking in accordance with ACI 318-14 17.4.2.6 or ACI 318-11 D.5.2.6, as applicable, N_b must be calculated using $K_{c,uncr}$ and $\Psi_{c,N} = 1.0$. See Table 1. For anchors in lightweight concrete, see ACI 318-14 17.2.6 or ACI 318-11 D.3.6, as applicable. The value of f'_c used for calculation must be limited to 8,000 psi (55 MPa) in accordance with ACI 318-14 17.2.7 or ACI 318-11 D.3.7, as applicable. Additional information for the determination of nominal bond strength in tension is given in Section 4.1.4 of this report.

4.1.4 Static Bond Strength in Tension: The nominal static bond strength of a single adhesive anchor or group of adhesive anchors in tension, N_a or N_{ag} , must be calculated in accordance with ACI 318-14 17.4.5 or ACI 318-11 D.5.5, as applicable. Bond strength values are a function of the concrete compressive strength, whether the concrete is cracked or uncracked, the concrete temperature range, the drilling method, and the installation conditions (dry or water-saturated, etc.). The resulting characteristic bond strength shall be multiplied by the associated strength reduction factor ϕ_{bn} as follows:

DRILLING METHOD	CONCRETE TYPE	PERMISSIBLE INSTALLATION CONDITIONS	BOND STRENGTH	ASSOCIATED STRENGTH REDUCTION FACTOR
Hammer-drill	Cracked and Uncracked	Dry	$\tau_{k,uncr}$ or $\tau_{k,cr}$	ϕ_d
		Water-saturated	$\tau_{k,uncr}$ or $\tau_{k,cr}$	ϕ_{ws}
		Water-filled hole	$\tau_{k,uncr}$ or $\tau_{k,cr}$	ϕ_{wf}
		Underwater application	$\tau_{k,uncr}$ or $\tau_{k,cr}$	ϕ_{uw}
Core Drilled with Roughening Tool or Hilti TE-CD or TE-YD Hollow Drill Bit	Cracked and Uncracked	Dry	$\tau_{k,uncr}$ or $\tau_{k,cr}$	ϕ_d
		Water-saturated	$\tau_{k,uncr}$ or $\tau_{k,cr}$	ϕ_{ws}
Core Drilled	Uncracked	Dry	$\tau_{k,uncr}$	ϕ_d
		Water-saturated	$\tau_{k,uncr}$	ϕ_{ws}

Figure 5 of this report presents a bond strength design selection flowchart. Strength reduction factors for determination of the bond strength are outlined in Table 1 of this report. Adjustments to the bond strength may also be made for increased concrete compressive strength as noted in the footnotes to the bond strength tables.

4.1.5 Static Steel Strength in Shear: The nominal static strength of a single anchor in shear as governed by the steel, V_{sa} , in accordance with ACI 318-14 17.5.1.2 or ACI 318-11 D.6.1.2, as applicable, and strength reduction factors, ϕ , in accordance with ACI 318-14 17.3.3 or ACI 318-11 D.4.3, as applicable, are given in the tables outlined in Table 1 for the anchor element types included in this report.

4.1.6 Static Concrete Breakout Strength in Shear: The nominal static concrete breakout strength of a single anchor or group of anchors in shear, V_{cb} or V_{cbg} , must be calculated in accordance with ACI 318-14 17.5.2 or ACI 318-11 D.6.2, as applicable, based on information given in the tables outlined in Table 1. The basic concrete breakout strength of a single anchor in shear, V_b , must be calculated in accordance with ACI 318-14 17.5.2.2 or ACI 318-11 D.6.2.2, as applicable, using the values of d given in the tables as outlined in Table 1 for the corresponding anchor steel in lieu of d_a (2018, 2015, 2012 and 2009 IBC). In addition, h_{ef} must be substituted for ℓ_e . In no case must ℓ_e exceed $8d$. The value of f'_c must be limited to a maximum of 8,000 psi (55 MPa) in accordance with ACI 318-14 17.2.7 or ACI 318-11 D.3.7, as applicable.

4.1.7 Static Concrete Pryout Strength in Shear: The nominal static pryout strength of a single anchor or group of anchors in shear, V_{cp} or V_{cpg} , must be calculated in accordance with ACI 318-14 17.5.3 or ACI 318-11 D.6.3, as applicable.

4.1.8 Interaction of Tensile and Shear Forces: For designs that include combined tension and shear, the interaction of tension and shear loads must be calculated in accordance with ACI 318-14 17.6 or ACI 318-11 D.7, as applicable.

4.1.9 Minimum Member Thickness, h_{min} , Anchor Spacing, s_{min} and Edge Distance, c_{min} : In lieu of ACI 318-14 17.7.1 and 17.7.3 or ACI 318-11 D.8.1 and D.8.3, as applicable, values of s_{min} and c_{min} described in this report must be observed for anchor design and installation. Likewise, in lieu of ACI 318-14 17.7.5 or ACI 318-11 D.8.5, as applicable, the minimum member thicknesses, h_{min} , described in this report must be observed for anchor design and installation. For adhesive anchors that will remain untorqued, ACI 318-14 17.7.4 or ACI 318-11 D.8.4, as applicable, applies.

For edge distances c_{ai} and anchor spacing s_{ai} , the maximum torque T_{max} shall comply with the following requirements:

REDUCED MAXIMUM INSTALLATION TORQUE $T_{max,red}$ FOR EDGE DISTANCES $c_{ai} < (5 \times d_a)$		
EDGE DISTANCE, c_{ai}	MINIMUM ANCHOR SPACING, s_{ai}	MAXIMUM TORQUE, $T_{max,red}$
1.75 in. (45 mm) $\leq c_{ai} < 5 \times d_a$	$5 \times d_a \leq s_{ai} < 16$ in.	$0.3 \times T_{max}$
	$s_{ai} \geq 16$ in. (406 mm)	$0.5 \times T_{max}$

4.1.10 Critical Edge Distance c_{ac} : In lieu of ACI 318-14 17.7.6 or ACI 318-11 D.8.6, as applicable, c_{ac} must be determined as follows:

$$c_{ac} = h_{ef} \cdot \left(\frac{\tau_{k,uncr}}{1160} \right)^{0.4} \cdot \left[3.1 - 0.7 \frac{h}{h_{ef}} \right] \quad \text{Eq. (4-1)}$$

where $\left[\frac{h}{h_{ef}} \right]$ need not be taken as larger than 2.4: and

$\tau_{k,uncr}$ is the characteristic bond strength in uncracked concrete stated in the tables of this report, whereby $\tau_{k,uncr}$ need not be taken as greater than:

$$\tau_{k,uncr} = \frac{k_{uncr} \sqrt{h_{ef} f'_c}}{\pi \cdot d_a}$$

4.1.11 Design Strength in Seismic Design Categories C, D, E and F: In structures assigned to Seismic Design Category C, D, E or F under the IBC or RC, the design must be performed according to ACI 318-14 17.2.3.1, ACI 318-

喜利得股份有限公司

送審專用

FOR REVIEW

11 Section D.3.3, as applicable. Modifications to ACI 318-14 17.2.3 shall be applied under Section 1905.1.8 of the 2018 and 2015 IBC. For the 2012 IBC, Section 1905.1.9 shall be omitted. Modifications to ACI 318-08 D.3.3 must be applied under Section 1908.1.9 of the 2009 IBC.

The nominal steel shear strength, V_{sa} , must be adjusted by $\alpha_{V,seis}$ as given in the tables summarized in Table 1 for the anchor element types included in this report. For tension, the nominal pullout strength $N_{p,cr}$ or bond strength τ_{cr} must be adjusted by $\alpha_{N,seis}$. See Tables 8, 9, 11, 12, 16, 17, 19, 20, 24, 28 and 29.

Modify ACI 318-11 Sections D.3.3.4.2, D.3.3.4.3(d) and D.3.3.5.2 to read as follows:

ACI 318-11 D.3.3.4.2 - Where the tensile component of the strength-level earthquake force applied to anchors exceeds 20 percent of the total factored anchor tensile force associated with the same load combination, anchors and their attachments shall be designed in accordance with ACI 318-11 D.3.3.4.3. The anchor design tensile strength shall be determined in accordance with ACI 318-11 D.3.3.4.4

Exception:

1. Anchors designed to resist wall out-of-plane forces with design strengths equal to or greater than the force determined in accordance with ASCE 7 Equation 12.11-1 or 12.14-10 shall be deemed to satisfy ACI 318-11 D.3.3.4.3(d).

ACI 318-11 D.3.3.4.3(d) – The anchor or group of anchors shall be designed for the maximum tension obtained from design load combinations that include E, with E increased by Ω_0 . The anchor design tensile strength shall be calculated from ACI 318-11 D.3.3.4.4.

ACI 318-11 D.3.3.5.2 – Where the shear component of the strength-level earthquake force applied to anchors exceeds 20 percent of the total factored anchor shear force associated with the same load combination, anchors and their attachments shall be designed in accordance with ACI 318-11 D.3.3.5.3. The anchor design shear strength for resisting earthquake forces shall be determined in accordance with ACI 318-11 D.6.

Exceptions:

1. For the calculation of the in-plane shear strength of anchor bolts attaching wood sill plates of bearing or non-bearing walls of light-frame wood structures to foundations or foundation stem walls, the in-plane shear strength in accordance with ACI 318-11 D.6.2 and D.6.3 need not be computed and ACI 318-11 D.3.3.5.3 need not apply provided all of the following are satisfied:

1.1. The allowable in-plane shear strength of the anchor is determined in accordance with AF&PA NDS Table 11E for lateral design values parallel to grain.

1.2. The maximum anchor nominal diameter is $5/8$ inch (16 mm).

1.3. Anchor bolts are embedded into concrete a minimum of 7 inches (178 mm).

1.4. Anchor bolts are located a minimum of $1\ 3/4$ inches (45 mm) from the edge of the concrete parallel to the length of the wood sill plate.

1.5. Anchor bolts are located a minimum of 15 anchor diameters from the edge of the concrete perpendicular to the length of the wood sill plate.

1.6. The sill plate is 2-inch or 3-inch nominal thickness.

2. For the calculation of the in-plane shear strength of anchor bolts attaching cold-formed steel track of bearing or non-bearing walls of light-frame construction to foundations or foundation stem walls, the in-plane shear strength in accordance with ACI 318-11 D.6.2 and D.6.3, need not be computed and ACI 318-11 D.3.3.5.3 need not apply provided all of the following are satisfied:

2.1. The maximum anchor nominal diameter is $5/8$ inch (16 mm).

2.2. Anchors are embedded into concrete a minimum of 7 inches (178 mm).

2.3. Anchors are located a minimum of $1\ 3/4$ inches (45 mm) from the edge of the concrete parallel to the length of the track.

2.4. Anchors are located a minimum of 15 anchor diameters from the edge of the concrete perpendicular to the length of the track.

2.5. The track is 33 to 68 mil designation thickness.

Allowable in-plane shear strength of exempt anchors, parallel to the edge of concrete shall be permitted to be determined in accordance with AISI S100 Section E3.3.1.

3. In light-frame construction, bearing or nonbearing walls, shear strength of concrete anchors less than or equal to 1 inch [25 mm] in diameter attaching a sill plate or track to foundation or foundation stem wall need not satisfy ACI 318-11 D.3.3.5.3(a) through (c) when the design strength of the anchors is determined in accordance with ACI 318-11 D.6.2.1(c).

4.2 Strength Design of Post-Installed Reinforcing Bars:

4.2.1 General: The design of straight post-installed deformed reinforcing bars must be determined in accordance with ACI 318 rules for cast-in place reinforcing bar development and splices and this report.

Examples of typical applications for the use of post-installed reinforcing bars are illustrated in Figures 2 and 3 of this report. A design example in accordance with the 2018 and 2015 IBC based on ACI 318-14 is given in Figure 8 of this report.

4.2.2 Determination of bar development length l_d : Values of l_d must be determined in accordance with the ACI 318 development and splice length requirements for straight cast-in place reinforcing bars.

Exceptions:

1. For uncoated and zinc-coated (galvanized) post-installed reinforcing bars, the factor Ψ_e shall be taken as 1.0. For all other cases, the requirements in ACI 318-14 25.4.2.4 or ACI 318-11 12.2.4 (b) shall apply.

2. When using alternate methods to calculate the development length (e.g., anchor theory), the applicable factors for post-installed anchors generally apply.

4.2.3 Minimum Member Thickness, h_{min} , Minimum Concrete Cover, $c_{c,min}$, Minimum Concrete Edge Distance, $c_{b,min}$, Minimum Spacing, s_{min} : For post-installed reinforcing bars, there is no limit on the minimum member thickness. In general, all requirements on concrete cover and spacing applicable to straight cast-in bars designed in accordance with ACI 318 shall be maintained.

吉利得股份有限公司
送審專用
FOR REVIEW

For post-installed reinforcing bars installed at embedment depths, h_{ef} , larger than $20d$ ($h_{ef} > 20d$), the minimum concrete cover shall be as follows:

REBAR SIZE	MINIMUM CONCRETE COVER, $C_{c,min}$
$d_b \leq \text{No. 6 (16 mm)}$	$1\frac{3}{16}$ in. (30mm)
$\text{No. 6} < d_b \leq \text{No. 10}$ (16mm < $d_b \leq 32\text{mm}$)	$1\frac{9}{16}$ in. (40mm)

The following requirements apply for minimum concrete edge and spacing for $h_{ef} > 20d$:

Required minimum edge distance for post-installed reinforcing bars (measured from the center of the bar):

$$C_{b,min} = d_o/2 + C_{c,min}$$

Required minimum center-to-center spacing between post-installed bars:

$$S_{b,min} = d_o + C_{c,min}$$

Required minimum center-to-center spacing from existing (parallel) reinforcing:

$$S_{b,min} = d_b/2 \text{ (existing reinforcing)} + d_o/2 + C_{c,min}$$

All other requirements applicable to straight cast-in place bars designed in accordance with ACI 318 shall be maintained.

4.2.4 Design Strength in Seismic Design Categories C, D, E and F: In structures assigned to Seismic Category C, D, E or F under the IBC or IRC, design of straight post-installed reinforcing bars must take into account the provisions of ACI 318-14 Chapter 18 or ACI 318-11 Chapter 21, as applicable.

4.3 Installation:

Installation parameters are illustrated in Figures 1 and 4. Installation must be in accordance with ACI 318-14 17.8.1 and 17.8.2 or ACI 318-11 D.9.1 and D.9.2, as applicable. Anchor and post-installed reinforcing bar locations must comply with this report and the plans and specifications approved by the code official. Installation of the Hilti HIT-RE 500 V3 Adhesive Anchor and Post-Installed Reinforcing Bar Systems must conform to the manufacturer's printed installation instructions (MPII) included in each unit package consolidated as Figures 9A and 9B of this report. The MPII contains additional requirements for combinations of drill hole depth, diameter, drill bit type, hole preparation, and dispensing tools.

The initial cure time, $t_{cure,ini}$, as noted in Figure 9A of this report, is intended for rebar applications only and is the time where rebar and concrete formwork preparation may continue. Between the initial cure time and the full cure time, $t_{cure,final}$, the adhesive has a limited load bearing capacity. Do not apply a torque or load on the rebar during this time

4.4 Special Inspection:

Periodic special inspection must be performed where required in accordance with Section 1705.1.1 and Table 1705.3 of the 2018, 2015 and 2012 IBC, or Section 1704.15 and Table 1704.4 of the 2009 IBC, as applicable, and this report. The special inspector must be on the jobsite initially during anchor or post-installed reinforcing bar installation to verify anchor or post-installed reinforcing bar type and dimensions, concrete type, concrete compressive strength, adhesive identification and expiration date, hole dimensions, hole cleaning procedures, spacing, edge distances, concrete thickness, anchor or post-installed reinforcing bar embedment, tightening torque and adherence to the manufacturer's printed installation instructions.

The special inspector must verify the initial installations of each type and size of adhesive anchor or post-installed reinforcing bar by construction personnel on site. Subsequent installations of the same anchor or post-installed reinforcing bar type and size by the same construction personnel are permitted to be performed in the absence of the special inspector. Any change in the anchor or post-installed reinforcing bar product being installed or the personnel performing the installation requires an initial inspection. For ongoing installations over an extended period, the special inspector must make regular inspections to confirm correct handling and installation of the product.

Continuous special inspection of adhesive anchors or post-installed reinforcing bar installed in horizontal or upwardly inclined orientations to resist sustained tension loads shall be performed in accordance with ACI 318-14 17.8.2.4, 26.7.1(h), and 26.13.3.2(c) or ACI 318-11 D.9.2.4, as applicable.

Under the IBC, additional requirements as set forth in Sections 1705, 1706, and 1707 must be observed, where applicable.

5.0 CONDITIONS OF USE

The Hilti HIT-RE 500 V3 Adhesive Anchor System and Post-Installed Reinforcing Bar System described in this report complies with, or is a suitable alternative to what is specified in, the codes listed in Section 1.0 of this report, subject to the following conditions:

- 5.1** Hilti HIT-RE 500 V3 Adhesive anchors and post-installed reinforcing bars must be installed in accordance with the manufacturer's printed installation instructions (MPII) as included in the adhesive packaging and consolidated as Figures 9A and 9B of this report.
- 5.2** The anchors and post-installed reinforcing bars must be installed in cracked and uncracked normal-weight concrete having a specified compressive strength $f'_c = 2,500$ psi to 8,500 psi (17.2 MPa to 58.6 MPa) [minimum of 24 MPa is required under ADIBC Appendix L, Section 5.1.1].
- 5.3** The values of f'_c used for calculation purposes must not exceed 8,000 psi (55.1 MPa).
- 5.4** The concrete shall have attained its minimum design strength prior to installation of the Hilti HIT-RE 500 V3 adhesive anchors or post-installed reinforcing bars.
- 5.5** Anchors and post-installed reinforcing bars must be installed in concrete base materials in holes drilled using carbide-tipped drill bits manufactured with the range of maximum and minimum drill-tip dimensions specified in ANSI B212.15-1994, or diamond core drill bits, as detailed in Figure 9A. Use of the Hilti TE-YRT Roughening Tool in conjunction with diamond core bits must be as detailed in Figure 9B.
- 5.6** Loads applied to the anchors must be adjusted in accordance with Section 1605.2 of the IBC for strength design.
- 5.7** Hilti HIT-RE 500 V3 adhesive anchors and post-installed reinforcing bars are recognized for use to resist short- and long-term loads, including seismic earthquake, subject to the conditions of this report.
- 5.8** In structures assigned to Seismic Design Category D, E or F under the IBC or IRC, anchor strength must be adjusted in accordance with Section 4.1.11 of this report, and post-installed reinforcing bars must comply with section 4.2.4 of this report.

喜利得股份有限公司
送審專用
FOR REVIEW

- 5.9** Hilti HIT-RE 500 V3 adhesive anchors and post-installed reinforcing bars are permitted to be installed in concrete that is cracked or that may be expected to crack during the service life of the anchor, subject to the conditions of this report.
- 5.10** Anchor strength design values must be established in accordance with Section 4.1 of this report.
- 5.11** Post-installed reinforcing bar development and splice length is established in accordance with Section 4.2 of this report.
- 5.12** Minimum anchor spacing and edge distance as well as minimum member thickness must comply with the values noted in this report.
- 5.13** Post-installed reinforcing bar spacing, minimum member thickness, and cover distance must be in accordance with the provisions of ACI 318 for cast-in place bars and section 4.2.3 of this report.
- 5.14** Prior to anchor installation, calculations and details demonstrating compliance with this report must be submitted to the code official. The calculations and details must be prepared by a registered design professional where required by the statutes of the jurisdiction in which the project is to be constructed.
- 5.15** Anchors and post-installed reinforcing bars are not permitted to support fire-resistive construction. Where not otherwise prohibited by the code, Hilti HIT-RE 500 V3 adhesive anchors and post-installed reinforcing bars are permitted for installation in fire-resistive construction provided that at least one of the following conditions is fulfilled:
- Anchors and post-installed reinforcing bars are used to resist wind or seismic forces only.
 - Anchors and post-installed reinforcing bars that support gravity load-bearing structural elements are within a fire-resistive envelope or a fire-resistive membrane, are protected by approved fire-resistive materials, or have been evaluated for resistance to fire exposure in accordance with recognized standards.
 - Anchors and post-installed reinforcing bars are used to support nonstructural elements.
- 5.16** Since an ICC-ES acceptance criteria for evaluating data to determine the performance of adhesive anchors and post-installed reinforcing bars subjected to fatigue or shock loading is unavailable at this time, the use of these anchors under such conditions is beyond the scope of this report.
- 5.17** Use of zinc-plated carbon steel threaded rods or steel reinforcing bars is limited to dry, interior locations.
- 5.18** Use of hot-dipped galvanized carbon steel and stainless steel rods is permitted for exterior exposure or damp environments.
- 5.19** Steel anchoring materials in contact with preservative-treated and fire-retardant-treated wood must be of zinc-coated carbon steel or stainless steel. The minimum coating weights for zinc-coated steel must comply with ASTM A153. Periodic special inspection must be provided in accordance with Section 4.4 of this report. Continuous special inspection for anchors and post-installed reinforcing bars installed in horizontal or upwardly inclined orientations to resist sustained tension loads must be provided in accordance with Section 4.4 of this report.
- 5.20** Installation of anchors and post-installed reinforcing bars in horizontal or upwardly inclined orientations to resist sustained tension loads shall be performed by

personnel certified by an applicable certification program in accordance with ACI 318-14 17.8.2.2 or 17.8.2.3, or ACI 318-11 D.9.2.2 or D.9.2.3, as applicable.

- 5.21** Hilti HIT-RE 500 V3 adhesive anchors and post-installed reinforcing bars may be used to resist tension and shear forces in floor, wall, and overhead installations only if installation is into concrete with a temperature between 23°F and 104°F (-5°C and 40°C) for threaded rods, rebar, and Hilti HIS-(R)N inserts. Overhead installations for hole diameters larger than $\frac{7}{16}$ -inch or 10mm require the use of piston plugs (HIT-SZ, -IP) during injection to the back of the hole. $\frac{7}{16}$ -inch or 10mm diameter holes may be injected directly to the back of the hole with the use of extension tubing on the end of the nozzle. The anchor or post-installed reinforcing bars must be supported until fully cured (i.e., with Hilti HIT-OHW wedges, or other suitable means). Where temporary restraint devices are used, their use shall not result in impairment of the anchor shear resistance. Installations in concrete temperatures below 41°F (5°C) require the adhesive to be conditioned to a minimum temperature of 41°F (5°C).
- 5.22** Anchors and post-installed reinforcing bars shall not be used for applications where the concrete temperature can rise from 40°F or less to 80°F or higher within a 12-hour period. Such applications may include but are not limited to anchorage of building façade systems and other applications subject to direct sun exposure.
- 5.23** Hilti HIT-RE 500 V3 adhesives are manufactured by Hilti GmbH, Kaufering, Germany, under a quality-control program with inspections by ICC-ES.
- 5.24** Hilti HIS-N and HIS-RN inserts are manufactured by Hilti (China) Ltd., Guangdong, China, under a quality-control program with inspections by ICC-ES.

6.0 EVIDENCE SUBMITTED

Data in accordance with the ICC-ES Acceptance Criteria for Post-installed Adhesive Anchors in Concrete (AC308), dated June 2019 (Editorially revised March 2018), which incorporates requirements in ACI 355.4-11, including but not limited to tests under freeze/thaw conditions (Table 3.2, test series 6), and Table 3.8 for evaluating post-installed reinforcing bars.

7.0 IDENTIFICATION

- 7.1** Hilti HIT-RE 500 V3 adhesive is identified by packaging labeled with the manufacturer's name (Hilti Corp.) and address, product name, lot number, expiration date, and evaluation report number (ESR-3814).
- 7.2** Hilti HIS-N and HIS-RN inserts are identified by packaging labeled with the manufacturer's name (Hilti Corp.) and address, anchor name and size, and evaluation report number (ESR-3814). Threaded rods, nuts, washers, bolts, cap screws, and deformed reinforcing bars are standard elements and must conform to applicable national or international specifications.
- 7.3** The report holder's contact information is the following:

HILTI, INC.

7250 DALLAS PARKWAY, SUITE 3000

PLANO, TEXAS 75024

(800) 879-8000

www.us.hilti.com

HiltiTechEng@us.hilti.com

喜利得股份有限公司

送審專用

FOR REVIEW

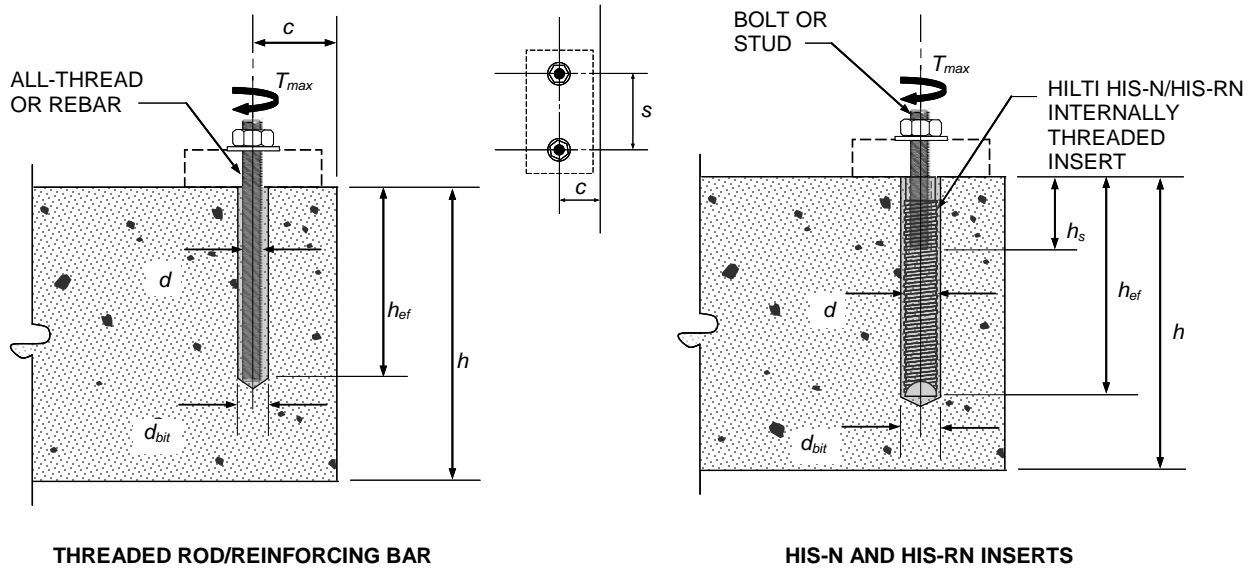

FIGURE 1—INSTALLATION PARAMETERS FOR POST-INSTALLED ADHESIVE ANCHORS

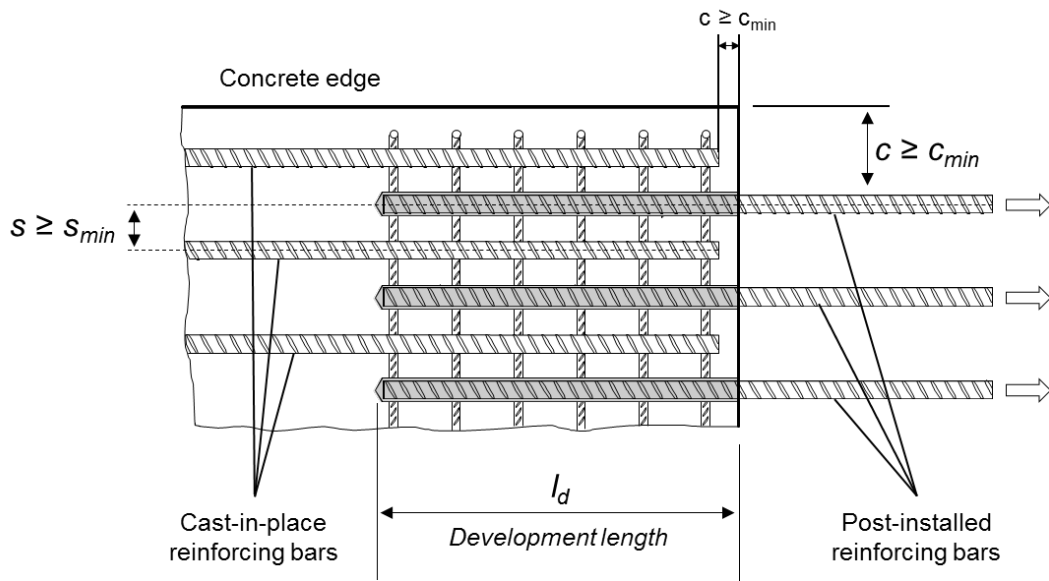

FIGURE 2—INSTALLATION PARAMETERS FOR POST-INSTALLED REINFORCING BARS

喜利得股份有限公司
 送審專用
 FOR REVIEW

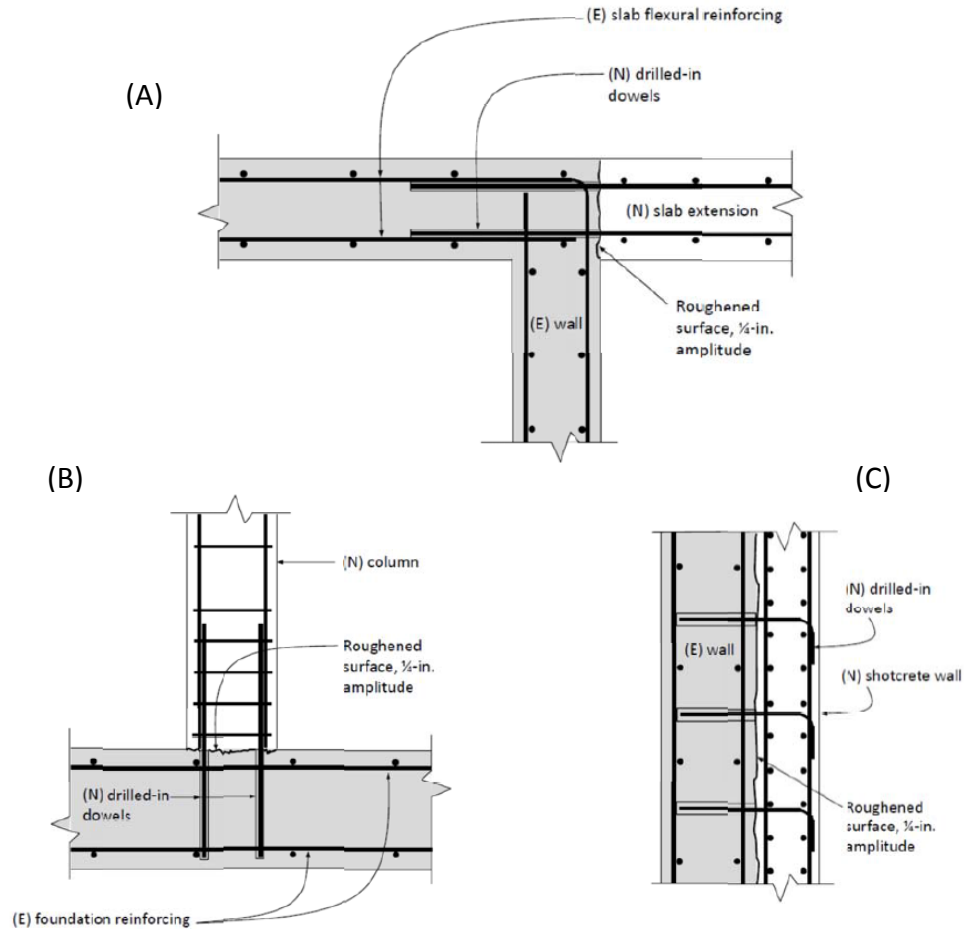
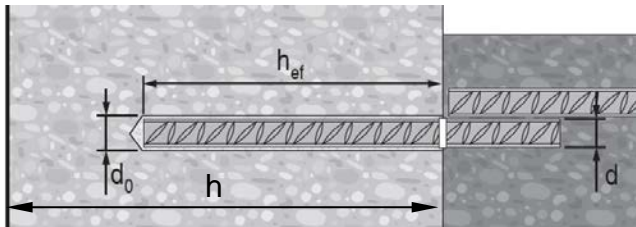

FIGURE 3—(A) TENSION LAP SPLICE WITH EXISTING FLEXURAL REINFORCEMENT; (B) TENSION DEVELOPMENT OF COLUMN DOWELS; (C) DEVELOPMENT OF SHEAR DOWELS FOR NEW ONLY SHEAR WALL

DEFORMED REINFORCEMENT



EU Rebar

$\varnothing d$ [mm]	$\varnothing d_0$ [mm]	h_{ef} [mm]
8	12	60...480
10	14	60...600
12	16	70...720
14	18	75...840
16	20	80...960
18	22	85...1080
20	25	90...1200
22	28	95...1320
24	32	96...1440
25	32	100...1500
26	35	104...1560
28	35	112...1680
30	37	120...1800
32	40	128...1920

US Rebar

d	$\varnothing d_0$ [inch]	h_{ef} [inch]
#3	1/2	2 3/8...22 1/2
#4	5/8	2 3/4...30
#5	3/4	3 1/8...37 1/2
#6	7/8	3 1/2...15
	1	15...45
#7	1	3 1/2...17 1/2
	1 1/8	17 1/2...52 1/2
	1 1/8	4...20
#8	1 1/4	20...60
#9	1 3/8	4 1/2...67 1/2
#10	1 1/2	5...75
#11	1 3/4	5 1/2...82 1/2

CA Rebar

d	$\varnothing d_0$ [inch]	h_{ef} [mm]
10 M	9/16	70...678
15 M	3/4	80...960
20 M	1	90...1170
25 M	1 1/4 (32 mm)	101...1512
30 M	1 1/2	120...1794

FIGURE 4—INSTALLATION PARAMETERS

喜利得股份有限公司
送審專用
FOR REVIEW

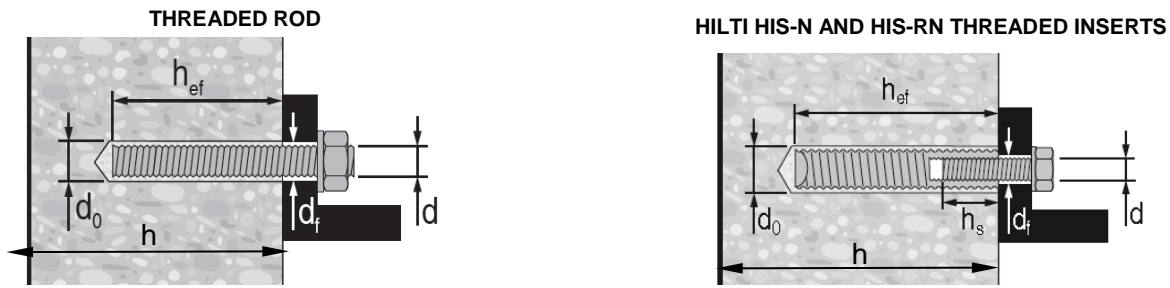

HAS / HIT-V

Ø d [inch]	Ø d ₀ [inch]	h _{ef} [inch]	Ø d _f [inch]	T _{max} [ft-lb]	T _{max} [Nm]
3/8	7/16	2 3/8... 7 1/2	7/16	15	20
1/2	9/16	2 3/4... 10	9/16	30	41
5/8	3/4	3 1/8... 12 1/2	11/16	60	81
3/4	7/8	3 1/2... 15	13/16	100	136
7/8	1	3 1/2... 17 1/2	15/16	125	169
1	1 1/8	4... 20	1 1/8	150	203
1 1/4	1 3/8	5... 25	1 3/8	200	271

Ø d [inch]	Ø d ₀ [inch]	h _{ef} [inch]	Ø d _f [inch]	h _s [inch]	T _{max} [ft-lb]	T _{max} [Nm]
3/8	11/16	4 3/8	7/16	3/8... 15/16	15	20
1/2	7/8	5	9/16	1/2... 1 3/16	30	41
5/8	1 1/8	6 3/4	11/16	5/8... 1 1/2	60	81
3/4	1 1/4	8 1/8	13/16	3/4... 1 7/8	100	136



HIT-V

Ø d [mm]	Ø d ₀ [mm]	h _{ef} [mm]	Ø d _f [mm]	T _{max} [Nm]
M8	10	60...160	9	10
M10	12	60...200	12	20
M12	14	70...240	14	40
M16	18	80...320	18	80
M20	22	90...400	22	150
M24	28	100...480	26	200
M27	30	110...540	30	270
M30	35	120...600	33	300

Ø d [mm]	Ø d ₀ [mm]	h _{ef} [mm]	Ø d _f [mm]	h _s [mm]	T _{max} [Nm]
M8	14	90	9	8...20	10
M10	18	110	12	10...25	20
M12	22	125	14	12...30	40
M16	28	170	18	16...40	80
M20	32	205	22	20...50	150

FIGURE 4—INSTALLATION PARAMETERS (Continued)

TABLE 1—DESIGN TABLE INDEX

Design Table		Fractional		Metric			
		Table	Page	Table	Page		
	Steel Strength - N_{sa} , V_{sa}	6A	13	14	20		
	Concrete Breakout - N_{cb} , N_{cbg} , V_{cb} , V_{cbg} , V_{cp} , V_{cpg}	7	15	15	21		
	Bond Strength - N_a , N_{ag}	11-13	18-19	19-21	25-26		
	Steel Strength - N_{sa} , V_{sa}	26	30	26	30		
	Concrete Breakout - N_{cb} , N_{cbg} , V_{cb} , V_{cbg} , V_{cp} , V_{cpg}	27	31	27	31		
	Bond Strength - N_a , N_{ag}	28-30	32-33	28-30	32-33		
Design Table		Fractional		EU Metric		Canadian	
		Table	Page	Table	Page	Table	Page
	Steel Strength - N_{sa} , V_{sa}	6B	14	14	20	22	27
	Concrete Breakout - N_{cb} , N_{cbg} , V_{cb} , V_{cbg} , V_{cp} , V_{cpg}	7	15	15	21	23	27
	Bond Strength - N_a , N_{ag}	8-10	16-17	16-18	22-24	24-25B	28-29
	Determination of development length for post-installed reinforcing bar connections	31	34	32	34	33	35

喜利得股份有限公司

送審專用

FOR REVIEW

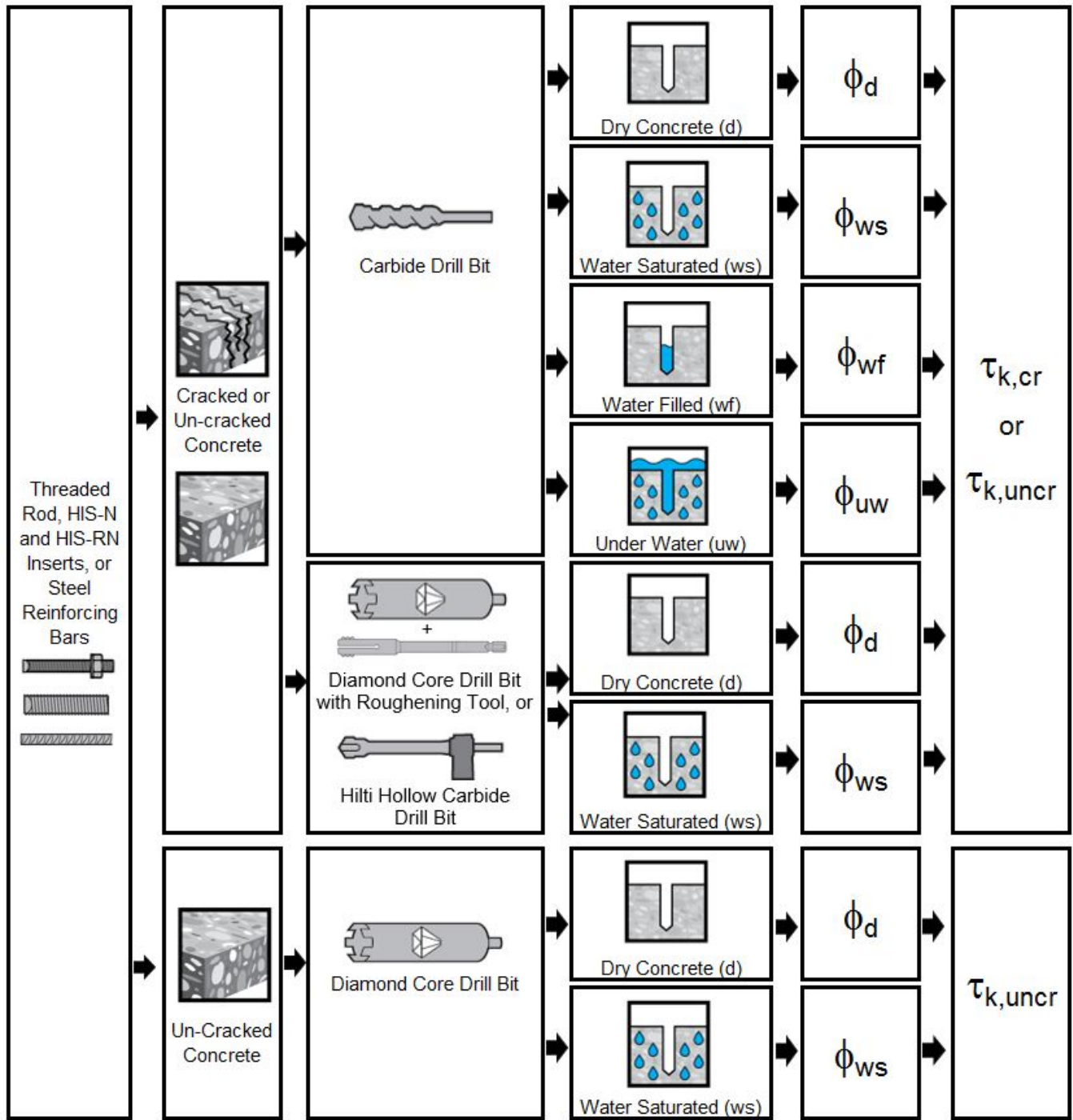

FIGURE 5—FLOWCHART FOR THE ESTABLISHMENT OF DESIGN BOND STRENGTH

喜利得股份有限公司
 送審專用
 FOR REVIEW

TABLE 2—SPECIFICATIONS AND PHYSICAL PROPERTIES OF COMMON CARBON AND STAINLESS STEEL THREADED ROD MATERIALS¹

THREADED ROD SPECIFICATION			Minimum specified ultimate strength, f_{Uta}	Minimum specified yield strength 0.2 percent offset, f_{ya}	f_{Uta}/f_{ya}	Elongation, min. percent ⁷	Reduction of Area, min. percent	Specification for nuts ⁸
CARBON STEEL	ASTM A193 ² Grade B7 ≤ 2 1/2 in. (≤ 64 mm)	psi (MPa)	125,000 (862)	105,000 (724)	1.19	16	50	ASTM A563 Grade DH
	ASTM F568M ³ Class 5.8 M5 (1/4 in.) to M24 (1 in.) (equivalent to ISO 898-1)	psi (MPa)	72,500 (500)	58,000 (400)	1.25	10	35	ASTM A563 Grade DH ⁹ DIN 934 (8-A2K)
	ASTM F1554, Grade 36 ⁷	psi (MPa)	58,000 (400)	36,000 (248)	1.61	23	40	ASTM A194 or ASTM A563
	ASTM F1554, Grade 55 ⁷	psi (MPa)	75,000 (517)	55,000 (379)	1.36	21	30	ASTM A194 or ASTM A563
	ASTM F1554, Grade 105 ⁷	psi (MPa)	125,000 (862)	105,000 (724)	1.19	15	45	ASTM A194 or ASTM A563
	ISO 898-1 ⁴ Class 5.8	MPa (psi)	500 (72,500)	400 (58,000)	1.25	22	-	DIN 934 Grade 6
	ISO 898-1 ⁴ Class 8.8	MPa (psi)	800 (116,000)	640 (92,800)	1.25	12	52	DIN 934 Grade 8
STAINLESS STEEL	ASTM F593 ⁵ CW1 (316) 1/4-in. to 5/8-in.	psi (MPa)	100,000 (689)	65,000 (448)	1.54	20	-	ASTM F594
	ASTM F593 ⁵ CW2 (316) 3/4-in. to 1 1/2-in.	psi (MPa)	85,000 (586)	45,000 (310)	1.89	25	-	ASTM F594
	ASTM A193 Grade 8(M), Class 1 ² - 1 1/4-in.	psi (MPa)	75,000 (517)	30,000 (207)	2.50	30	50	ASTM F594
	ISO 3506-1 ⁶ A4-70 M8 – M24	MPa (psi)	700 (101,500)	450 (65,250)	1.56	40	-	ISO 4032
	ISO 3506-1 ⁶ A4-50 M27 – M30	MPa (psi)	500 (72,500)	210 (30,450)	2.38	40	-	ISO 4032

¹Hilti HIT-RE 500 V3 adhesive may be used in conjunction with all grades of continuously threaded carbon or stainless steel rod (all-thread) that comply with the code reference standards and that have thread characteristics comparable with ANSI B1.1 UNC Coarse Thread Series or ANSI B1.13M M Profile Metric Thread Series. Values for threaded rod types and associated nuts supplied by Hilti are provided here.

²Standard Specification for Alloy-Steel and Stainless Steel Bolting Materials for High-Temperature Service

³Standard Specification for Carbon and Alloy Steel Externally Threaded Metric Fasteners

⁴Mechanical properties of fasteners made of carbon steel and alloy steel – Part 1: Bolts, screws and studs

⁵Standard Steel Specification for Stainless Steel Bolts, Hex Cap Screws, and Studs

⁶Mechanical properties of corrosion-resistant stainless steel fasteners – Part 1: Bolts, screws and studs

⁷Based on 2-in. (50 mm) gauge length except for A 193, which are based on a gauge length of 4d and ISO 898, which is based on 5d.

⁸Nuts of other grades and styles having specified proof load stresses greater than the specified grade and style are also suitable. Nuts must have specified proof load stresses equal to or greater than the minimum tensile strength of the specified threaded rod.

⁹Nuts for fractional rods.

TABLE 3—SPECIFICATIONS AND PHYSICAL PROPERTIES OF COMMON STEEL REINFORCING BARS

REINFORCING BAR SPECIFICATION		Minimum specified ultimate strength, f_{Uta}	Minimum specified yield strength, f_{ya}
ASTM A615 ¹ Gr. 60	psi (MPa)	90,000 (620)	60,000 (414)
ASTM A615 ¹ Gr. 40	psi (MPa)	60,000 (414)	40,000 (276)
ASTM A706 ² Gr. 60	psi (MPa)	80,000 (550)	60,000 (414)
DIN 488 ³ BSt 500	MPa (psi)	550 (79,750)	500 (72,500)
CAN/CSA-G30.18 ⁴ Gr. 400	MPa (psi)	540 (78,300)	500 (72,500)

¹Standard Specification for Deformed and Plain Carbon Steel Bars for Concrete Reinforcement

²Standard Specification for Low Alloy Steel Deformed and Plain Bars for Concrete Reinforcement

³Reinforcing steel; reinforcing steel bars; dimensions and masses

⁴Billet-Steel Bars for Concrete Reinforcement

喜利得股份有限公司
(58,000)

送審專用

FOR REVIEW

TABLE 4—SPECIFICATIONS AND PHYSICAL PROPERTIES OF FRACTIONAL AND METRIC HIS-N AND HIS-RN INSERTS

HILTI HIS-N AND HIS-RN INSERTS		Minimum specified ultimate strength, f_{uta}	Minimum specified yield strength, f_{ya}
			
Carbon Steel DIN EN 10277-3 11SMnPb30+c or DIN 1561 9SMnPb28K	psi (MPa)	71,050 (490)	56,550 (390)
Stainless Steel EN 10088-3 X5CrNiMo 17-12-2	psi (MPa)	101,500 (700)	50,750 (350)

TABLE 5—SPECIFICATIONS AND PHYSICAL PROPERTIES OF COMMON BOLTS, CAP SCREWS AND STUDS FOR USE WITH HIS-N AND HIS-RN INSERTS^{1,2}

BOLT, CAP SCREW OR STUD SPECIFICATION		Minimum specified ultimate strength f_{uta}	Minimum specified yield strength 0.2 percent offset f_{ya}	f_{uta}/f_{ya}	Elongation, min.	Reduction of Area, min.	Specification for nuts ⁶
							
ASTM A193 Grade B7	psi (MPa)	125,000 (862)	105,000 (724)	1.119	16	50	ASTM A563 Grade DH
SAE J429 ³ Grade 5	psi (MPa)	120,000 (828)	92,000 (634)	1.30	14	35	SAE J995
ASTM A325 ⁴ 1/2 to 1-in.	psi (MPa)	120,000 (828)	92,000 (634)	1.30	14	35	A563 C, C3, D, DH, DH3 Heavy Hex
ASTM A193 ⁵ Grade B8M (AISI 316) for use with HIS-RN	psi (MPa)	110,000 (759)	95,000 (655)	1.16	15	45	ASTM F594 ⁷ Alloy Group 1, 2 or 3
ASTM A193 ⁵ Grade B8T (AISI 321) for use with HIS-RN	psi (MPa)	125,000 (862)	100,000 (690)	1.25	12	35	ASTM F594 ⁷ Alloy Group 1, 2 or 3

¹Minimum Grade 5 bolts, cap screws or studs must be used with carbon steel HIS inserts.

²Only stainless steel bolts, cap screws or studs must be used with HIS-RN inserts.

³Mechanical and Material Requirements for Externally Threaded Fasteners

⁴Standard Specification for Structural Bolts, Steel, Heat Treated, 120/105 ksi Minimum Tensile Strength

⁵Standard Specification for Alloy-Steel and Stainless Steel Bolting Materials for High-Temperature Service

⁶Nuts must have specified minimum proof load stress equal to or greater than the specified minimum full-size tensile strength of the specified stud.

⁷Nuts for stainless steel studs must be of the same alloy group as the specified bolt, cap screw, or stud.

喜利得股份有限公司
送審專用
FOR REVIEW



Fractional Threaded Rod

Steel Strength

TABLE 6A—STEEL DESIGN INFORMATION FOR FRACTIONAL THREADED ROD

DESIGN INFORMATION		Symbol	Units	Nominal rod diameter (in.) ¹							
				3/8	1/2	5/8	3/4	7/8	1	1 1/4	
Rod O.D.		<i>d</i>	in. (mm)	0.375 (9.5)	0.5 (12.7)	0.625 (15.9)	0.75 (19.1)	0.875 (22.2)	1 (25.4)	1.25 (31.8)	
Rod effective cross-sectional area		<i>A_{se}</i>	in. ² (mm ²)	0.0775 (50)	0.1419 (92)	0.2260 (146)	0.3345 (216)	0.4617 (298)	0.6057 (391)	0.9691 (625)	
ISO 898-1 Class 5.8	Nominal strength as governed by steel strength	<i>N_{sa}</i>	lb (kN)	5,620 (25.0)	10,290 (45.8)	16,385 (72.9)	24,250 (107.9)	33,470 (148.9)	43,910 (195.3)	70,260 (312.5)	
		<i>V_{sa}</i>	lb (kN)	3,370 (15.0)	6,175 (27.5)	9,830 (43.7)	14,550 (64.7)	20,085 (89.3)	26,345 (117.2)	42,155 (187.5)	
	Reduction for seismic shear	<i>α_{v,seis}</i>	-	1.0							
	Strength reduction factor <i>φ</i> for tension ²	<i>φ</i>	-	0.65							
		Strength reduction factor <i>φ</i> for shear ²	<i>φ</i>	-	0.60						
ASTM A193 B7	Nominal strength as governed by steel strength	<i>N_{sa}</i>	lb (kN)	9,685 (43.1)	17,735 (78.9)	28,250 (125.7)	41,810 (186.0)	57,710 (256.7)	75,710 (336.8)	121,135 (538.8)	
		<i>V_{sa}</i>	lb (kN)	5,810 (25.9)	10,640 (47.3)	16,950 (75.4)	25,085 (111.6)	34,625 (154.0)	45,425 (202.1)	72,680 (323.3)	
	Reduction for seismic shear	<i>α_{v,seis}</i>	-	1.0							
	Strength reduction factor <i>φ</i> for tension ³	<i>φ</i>	-	0.75							
		Strength reduction factor <i>φ</i> for shear ³	<i>φ</i>	-	0.65						
ASTM F1554 Gr. 36	Nominal strength as governed by steel strength	<i>N_{sa}</i>	lb (kN)	- (36.6)	8,230 (36.6)	13,110 (58.3)	19,400 (86.3)	26,780 (119.1)	35,130 (156.3)	56,210 (250.0)	
		<i>V_{sa}</i>	lb (kN)	- (22.0)	4,940 (22.0)	7,865 (35.0)	11,640 (51.8)	16,070 (71.5)	21,080 (93.8)	33,725 (150.0)	
	Reduction factor, seismic shear	<i>α_{v,seis}</i>	-	0.6							
	Strength reduction factor <i>φ</i> for tension ³	<i>φ</i>	-	0.75							
		Strength reduction factor <i>φ</i> for shear ³	<i>φ</i>	-	0.65						
ASTM F1554 Gr. 55	Nominal strength as governed by steel strength	<i>N_{sa}</i>	lb (kN)	- (47.4)	10,645 (47.4)	16,950 (75.4)	25,090 (111.6)	34,630 (154.0)	45,430 (202.1)	72,685 (323.3)	
		<i>V_{sa}</i>	lb (kN)	- (28.4)	6,385 (28.4)	10,170 (45.2)	15,055 (67.0)	20,780 (92.4)	27,260 (121.3)	43,610 (194.0)	
	Reduction factor, seismic shear	<i>α_{v,seis}</i>	-	1.0							
	Strength reduction factor <i>φ</i> for tension ³	<i>φ</i>	-	0.75							
		Strength reduction factor <i>φ</i> for shear ³	<i>φ</i>	-	0.65						
ASTM F1554 Gr. 105	Nominal strength as governed by steel strength	<i>N_{sa}</i>	lb (kN)	- (78.9)	17,740 (78.9)	28,250 (125.7)	41,815 (186.0)	57,715 (256.7)	75,715 (336.8)	121,135 (538.8)	
		<i>V_{sa}</i>	lb (kN)	- (47.4)	10,645 (47.4)	16,950 (75.4)	25,090 (111.6)	34,630 (154.0)	45,430 (202.1)	72,680 (323.3)	
	Reduction factor, seismic shear	<i>α_{v,seis}</i>	-	1.0							
	Strength reduction factor <i>φ</i> for tension ³	<i>φ</i>	-	0.75							
		Strength reduction factor <i>φ</i> for shear ³	<i>φ</i>	-	0.65						
ASTM F593, CW Stainless	Nominal strength as governed by steel strength	<i>N_{sa}</i>	lb (kN)	7,750 (34.5)	14,190 (63.1)	22,600 (100.5)	28,435 (126.5)	39,245 (174.6)	51,485 (229.0)	- (-)	
		<i>V_{sa}</i>	lb (kN)	4,650 (20.7)	8,515 (37.9)	13,560 (60.3)	17,060 (75.9)	23,545 (104.7)	30,890 (137.4)	- (-)	
	Reduction factor, seismic shear	<i>α_{v,seis}</i>	-	0.8							
	Strength reduction factor <i>φ</i> for tension ²	<i>φ</i>	-	0.65							
		Strength reduction factor <i>φ</i> for shear ²	<i>φ</i>	-	0.60						
ASTM A193, Gr. 8(M), Class 1 Stainless	Nominal strength as governed by steel strength	<i>N_{sa}</i>	lb (kN)	-	-	-	-	-	-	55,240 (245.7)	
		<i>V_{sa}</i>	lb (kN)	-	-	-	-	-	-	33,145 (147.4)	
	Reduction factor, seismic shear	<i>α_{v,seis}</i>	-	0.8							
	Strength reduction factor <i>φ</i> for tension ²	<i>φ</i>	-	0.75							
		Strength reduction factor <i>φ</i> for shear ²	<i>φ</i>	-	0.65						

For SI: 1 inch = 25.4 mm, 1 lbf = 4.448 N. For pound-inch units: 1 mm = 0.03937 inches, 1 N = 0.2248 lbf

¹Values provided for common rod material types are based on specified strengths and calculated in accordance with ACI 318-14 Eq. (17.4.1.2) and Eq. (17.5.1.2b) or ACI 318-11 Eq. (D-2) and Eq. (D-29), as applicable. Nuts and washers must be appropriate for the rod.
²For use with the load combinations of IBC Section 1605.2, ACI 318-14 5.3 or ACI 318-11 9.2, as applicable, as set forth in ACI 318-14 17.3.3 or ACI 318-11 D.4.3, as applicable. If the load combinations of ACI 318-11 Appendix C are used, the appropriate value of *φ* must be determined in accordance with ACI 318-11 D.4.4. Values correspond to a brittle steel element.
³For use with the load combinations of IBC Section 1605.2, ACI 318-14 5.3 or ACI 318-11 9.2, as applicable, as set forth in ACI 318-14 17.3.3 or ACI 318-11 D.4.3, as applicable. If the load combinations of ACI 318-11 Appendix C are used, the appropriate value of *φ* must be determined in accordance with ACI 318-11 D.4.4. Values correspond to a ductile steel element.

喜利得股份有限公司
送審專用
FOR REVIEW



Fractional Reinforcing Bars

Steel Strength

TABLE 6B—STEEL DESIGN INFORMATION FOR FRACTIONAL REINFORCING BARS

DESIGN INFORMATION		Symbol	Units	Nominal Reinforcing bar size (Rebar)							
				#3	#4	#5	#6	#7	#8	#9	#10
Nominal bar diameter		d	in. (mm)	³ / ₈ (9.5)	¹ / ₂ (12.7)	⁵ / ₈ (15.9)	³ / ₄ (19.1)	⁷ / ₈ (22.2)	1 (25.4)	¹ / ₈ (28.6)	¹ / ₄ (31.8)
Bar effective cross-sectional area		A_{se}	in. ² (mm ²)	0.11 (71)	0.2 (129)	0.31 (200)	0.44 (284)	0.6 (387)	0.79 (510)	1.0 (645)	1.27 (819)
ASTM A615 Grade 40	Nominal strength as governed by steel strength	N_{sa}	lb (kN)	6,600 (29.4)	12,000 (53.4)	18,600 (82.7)	26,400 (117.4)	36,000 (160.1)	47,400 (210.9)	60,000 (266.9)	76,200 (339.0)
		V_{sa}	lb (kN)	3,960 (17.6)	7,200 (32.0)	11,160 (49.6)	15,840 (70.5)	21,600 (96.1)	28,440 (126.5)	36,000 (160.1)	45,720 (203.4)
	Reduction for seismic shear	$\alpha_{V,seis}$	-	0.70							
	Strength reduction factor ϕ for tension ²	ϕ	-	0.65							
				Strength reduction factor ϕ for shear ²							
				0.60							
ASTM A615 Grade 60	Nominal strength as governed by steel strength	N_{sa}	lb (kN)	9,900 (44.0)	18,000 (80.1)	27,900 (124.1)	39,600 (176.2)	54,000 (240.2)	71,100 (316.3)	90,000 (400.4)	114,300 (508.5)
		V_{sa}	lb (kN)	5,940 (26.4)	10,800 (48.0)	16,740 (74.5)	23,760 (105.7)	32,400 (144.1)	42,660 (189.8)	54,000 (240.2)	68,580 (305.1)
	Reduction for seismic shear	$\alpha_{V,seis}$	-	0.70							
	Strength reduction factor ϕ for tension ²	ϕ	-	0.65							
				Strength reduction factor ϕ for shear ²							
				0.60							
ASTM A706 Grade 60	Nominal strength as governed by steel strength	N_{sa}	lb (kN)	8,800 (39.1)	16,000 (71.2)	24,800 (110.3)	35,200 (156.6)	48,000 (213.5)	63,200 (281.1)	80,000 (355.9)	101,600 (452.0)
		V_{sa}	lb (kN)	5,280 (23.5)	9,600 (42.7)	14,880 (66.2)	21,120 (94.0)	28,800 (128.1)	37,920 (168.7)	48,000 (213.5)	60,960 (271.2)
	Reduction for seismic shear	$\alpha_{V,seis}$	-	0.70							
	Strength reduction factor ϕ for tension ³	ϕ	-	0.75							
				Strength reduction factor ϕ for shear ³							
				0.65							

For SI: 1 inch = 25.4 mm, 1 lbf = 4.448 N. For pound-inch units: 1 mm = 0.03937 inches, 1 N = 0.2248 lbf

¹ Values provided for common rod material types are based on specified strengths and calculated in accordance with ACI 318-14 Eq. (17.4.1.2) and Eq (17.5.1.2b) or ACI 318-11 Eq. (D-2) and Eq. (D-29). Nuts and washers must be appropriate for the rod.

² For use with the load combinations of IBC Section 1605.2, ACI 318-14 5.3 or ACI 318-11 9.2, as set forth in ACI 318-14 17.3.3 or ACI 318-11 D.4.3. If the load combinations of ACI 318-11 Appendix C are used, the appropriate value of ϕ must be determined in accordance with ACI 318-11 D.4.4. Values correspond to a brittle steel element.

³ For use with the load combinations of IBC Section 1605.2, ACI 318-14 5.3 or ACI 318-11 9.2, as set forth in ACI 318-14 17.3.3 or ACI 318-11 D.4.3. If the load combinations of ACI 318-11 Appendix C are used, the appropriate value of ϕ must be determined in accordance with ACI 318-11 D.4.4. Values correspond to a ductile steel element.

喜利得股份有限公司

送審專用

FOR REVIEW

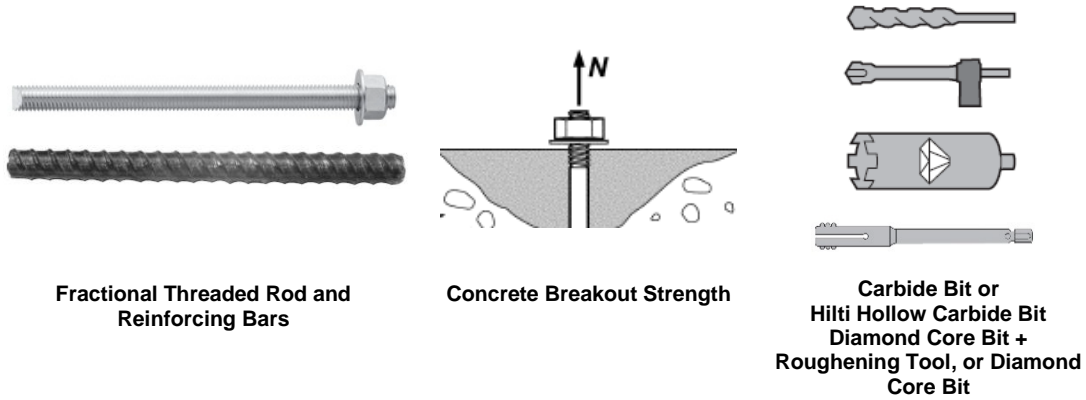

TABLE 7—CONCRETE BREAKOUT DESIGN INFORMATION FOR FRACTIONAL THREADED ROD AND REINFORCING BARS ALL DRILLING METHODS¹

DESIGN INFORMATION	Symbol	Units	Nominal rod diameter (in.) / Reinforcing bar size											
			3/8 or #3	1/2	#4	5/8	#5	3/4	#6	7/8	#7	1 or #8	#9	1 1/4 or #10
Effectiveness factor for cracked concrete	$k_{c,cr}$	in-lb (SI)	17 (7.1)											
Effectiveness factor for uncracked concrete	$k_{c,uncr}$	in-lb (SI)	24 (10)											
Minimum Embedment	$h_{ef,min}$	in. (mm)	2 3/8 (60)	2 3/4 (70)	2 3/8 (60)	3 1/8 (79)	3 (76)	3 1/2 (89)	3 (76)	3 1/2 (89)	3 3/8 (85)	4 (102)	4 1/2 (114)	5 (127)
Maximum Embedment	$h_{ef,max}$	in. (mm)	7 1/2 (191)	10 (254)	10 (254)	12 1/2 (318)	12 1/2 (318)	15 (381)	15 (381)	17 1/2 (445)	17 1/2 (445)	20 (508)	22 1/2 (572)	25 (635)
Min. anchor spacing ³	s_{min}	in. (mm)	1 7/8 (48)	2 1/2 (64)	2 1/2 (64)	3 1/8 (79)	3 1/8 (79)	3 3/4 (95)	3 3/4 (95)	4 3/8 (111)	4 3/8 (111)	5 (127)	5 5/8 (143)	6 1/4 (159)
Min. edge distance ³	c_{min}	-	5d; or see Section 4.1.9 of this report for design with reduced minimum edge distances											
Minimum concrete thickness	h_{min}	in. (mm)	$h_{ef} + 1 1/4$ ($h_{ef} + 30$)				$h_{ef} + 2d_o^{(4)}$							
Critical edge distance – splitting (for uncracked concrete)	c_{ac}	-	See Section 4.1.10 of this report.											
Strength reduction factor for tension, concrete failure modes, Condition B ²	ϕ	-	0.65											
Strength reduction factor for shear, concrete failure modes, Condition B ²	ϕ	-	0.70											

For SI: 1 inch \equiv 25.4 mm, 1 lbf = 4.448 N, 1 psi = 0.006897 MPa.
 For pound-inch units: 1 mm = 0.03937 inches, 1 N = 0.2248 lbf, 1 MPa = 145.0 psi

¹Additional setting information is described in Figure 9A and 9B, Manufacturers Printed Installation Instructions (MPII).
²Values provided for post-installed anchors under Condition B without supplementary reinforcement as defined in ACI 318-14 17.3.3 or ACI 318-11 D.4.3, as applicable.
³For installations with 1 3/4-inch edge distance, refer to Section 4.1.9 for spacing and maximum torque requirements.
⁴ d_o = hole diameter.

喜利得股份有限公司
 送審專用
 FOR REVIEW

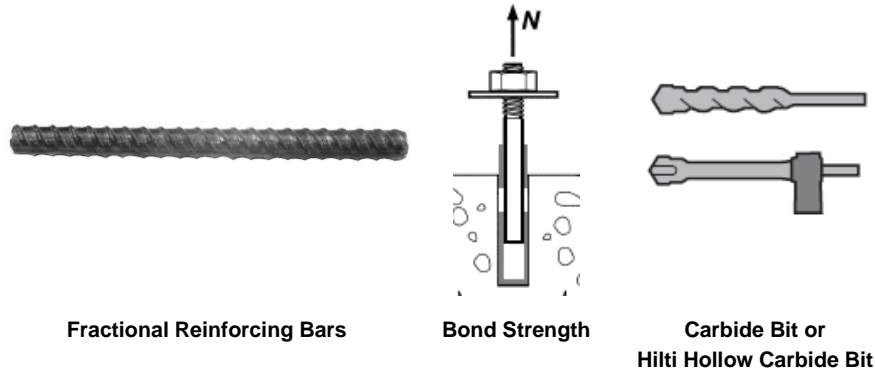

TABLE 8—BOND STRENGTH DESIGN INFORMATION FOR FRACTIONAL REINFORCING BARS IN HOLES DRILLED WITH A HAMMER DRILL AND CARBIDE BIT (OR HILTI HOLLOW CARBIDE DRILL BIT)¹

DESIGN INFORMATION		Symbol	Units	Nominal reinforcing bar size								
				#3	#4	#5	#6	#7	#8	#9	#10	
Minimum Embedment		$h_{ef,min}$	in. (mm)	2 ³ / ₈ (60)	2 ³ / ₈ (60)	3 (76)	3 (76)	3 ³ / ₈ (85)	4 (102)	4 ¹ / ₂ (114)	5 (127)	
Maximum Embedment		$h_{ef,max}$	in. (mm)	7 ¹ / ₂ (191)	10 (254)	12 ¹ / ₂ (318)	15 (381)	17 ¹ / ₂ (445)	20 (508)	22 ¹ / ₂ (572)	25 (635)	
Dry concrete and Water Saturated Concrete	Temperature range A ²	Characteristic bond strength in cracked concrete	$\tau_{k,cr}$	psi (MPa)	1,350 (9.3)	1,360 (9.4)	1,390 (9.6)	1,410 (9.7)	1,410 (9.7)	1,420 (9.8)	1,390 (9.6)	1,340 (9.3)
		Characteristic bond strength in uncracked concrete	$\tau_{k,uncr}$	psi (MPa)	1,770 (12.2)	1,740 (12.0)	1,720 (11.9)	1,690 (11.7)	1,670 (11.5)	1,640 (11.3)	1,620 (11.2)	1,590 (11.0)
	Temperature range B ²	Characteristic bond strength in cracked concrete	$\tau_{k,cr}$	psi (MPa)	930 (6.4)	940 (6.5)	960 (6.6)	970 (6.7)	980 (6.7)	980 (6.8)	960 (6.6)	930 (6.4)
		Characteristic bond strength in uncracked concrete	$\tau_{k,uncr}$	psi (MPa)	1,220 (8.4)	1,200 (8.3)	1,190 (8.2)	1,170 (8.1)	1,150 (7.9)	1,130 (7.8)	1,120 (7.7)	1,100 (7.6)
	Anchor Category		-	-	1	1	1	1	1	1	1	1
	Strength Reduction factor		ϕ_{cl}, ϕ_{ws}	-	0.65	0.65	0.65	0.65	0.65	0.65	0.65	0.65
Water-filled hole	Temperature range A ²	Characteristic bond strength in cracked concrete	$\tau_{k,cr}$	psi (MPa)	1,000 (6.9)	1,010 (6.9)	1,040 (7.2)	1,060 (7.3)	1,070 (7.4)	1,090 (7.5)	1,070 (7.4)	1,050 (7.2)
		Characteristic bond strength in uncracked concrete	$\tau_{k,uncr}$	psi (MPa)	1,300 (9.0)	1,290 (8.9)	1,290 (8.9)	1,280 (8.8)	1,270 (8.7)	1,260 (8.7)	1,240 (8.6)	1,240 (8.6)
	Temperature range B ²	Characteristic bond strength in cracked concrete	$\tau_{k,cr}$	psi (MPa)	690 (4.7)	700 (4.8)	720 (5.0)	730 (5.0)	740 (5.1)	750 (5.2)	740 (5.1)	720 (5.0)
		Characteristic bond strength in uncracked concrete	$\tau_{k,uncr}$	psi (MPa)	900 (6.2)	890 (6.1)	890 (6.1)	880 (6.1)	870 (6.0)	870 (6.0)	860 (5.9)	860 (5.9)
	Anchor Category		-	-	3	3	3	3	3	3	3	3
	Strength Reduction factor		ϕ_{wf}	-	0.45	0.45	0.45	0.45	0.45	0.45	0.45	0.45
Submerged concrete	Temperature range A ²	Characteristic bond strength in cracked concrete	$\tau_{k,cr}$	psi (MPa)	860 (5.9)	890 (6.1)	920 (6.3)	940 (6.5)	960 (6.6)	990 (6.9)	970 (6.7)	980 (6.8)
		Characteristic bond strength in uncracked concrete	$\tau_{k,uncr}$	psi (MPa)	1,140 (7.9)	1,130 (7.8)	1,140 (7.9)	1,140 (7.9)	1,140 (7.9)	1,150 (7.9)	1,130 (7.8)	1,150 (8.0)
	Temperature range B ²	Characteristic bond strength in cracked concrete	$\tau_{k,cr}$	psi (MPa)	590 (4.1)	610 (4.2)	630 (4.4)	650 (4.5)	660 (4.6)	690 (4.7)	670 (4.6)	680 (4.7)
		Characteristic bond strength in uncracked concrete	$\tau_{k,uncr}$	psi (MPa)	790 (5.4)	780 (5.4)	790 (5.4)	790 (5.4)	790 (5.4)	790 (5.5)	790 (5.4)	800 (5.5)
	Anchor Category		-	-	3	3	3	3	3	3	3	3
	Strength Reduction factor		ϕ_{uw}	-	0.45	0.45	0.45	0.45	0.45	0.45	0.45	0.45
Reduction for seismic tension		$\alpha_{N,seis}$	-	0.9	0.9	0.9	0.9	0.9	0.9	0.9	0.9	

For SI: 1 inch = 25.4 mm, 1 lbf = 4.448 N, 1 psi = 0.006897 MPa.
For pound-inch units: 1 mm = 0.03937 inches, 1 N = 0.2248 lbf, 1 MPa = 145.0 psi

¹Bond strength values correspond to concrete compressive strength $f'_c = 2,500$ psi (17.2 MPa) [minimum of 24 MPa is required under ADIBC Appendix A, Section 5.1.1]. For concrete compressive strength, f'_c , between 2,500 psi (17.2 MPa) and 8,000 psi (55.2 MPa), the tabulated characteristic bond strength may be increased by a factor of $(f'_c / 2,500)^{0.25}$ for uncracked concrete [For SI: $(f'_c / 17.2)^{0.25}$] and $(f'_c / 2,500)^{0.15}$ for cracked concrete [For SI: $(f'_c / 17.2)^{0.15}$]. See Section 4.1.4 of this report for bond strength determination.

²Temperature range A: Maximum short term temperature = 130°F (55°C), Maximum long term temperature = 110°F (43°C).
Temperature range B: Maximum short term temperature = 176°F (80°C), Maximum long term temperature = 110°F (43°C).

Short term elevated concrete temperatures are those that occur over brief intervals, e.g., as a result of diurnal cycling. Long term concrete temperatures are roughly constant over significant periods of time.

喜利得股份有限公司
送審專用
FOR REVIEW

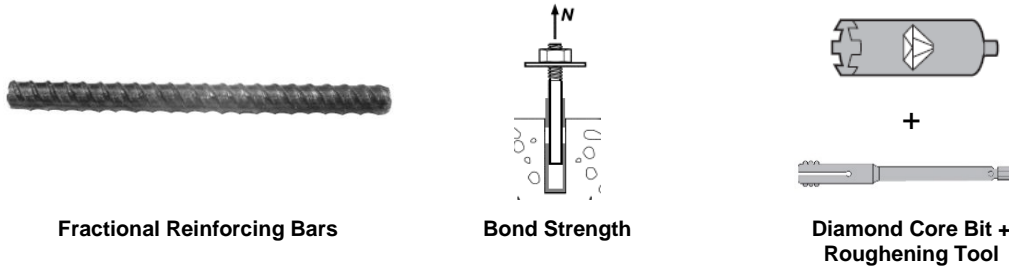

TABLE 9—BOND STRENGTH DESIGN INFORMATION FOR FRACTIONAL REINFORCING BARS IN HOLES CORE DRILLED WITH A DIAMOND CORE BIT AND ROUGHENED WITH A HILTI ROUGHENING TOOL¹

DESIGN INFORMATION			Symbol	Units	Nominal reinforcing bar size					
					#5	#6	#7	#8	#9	
Minimum Embedment			$h_{ef,min}$	in. (mm)	3 (76)	3 (76)	3 ³ / ₈ (85)	4 (102)	4 ¹ / ₂ (115)	
Maximum Embedment			$h_{ef,max}$	in. (mm)	12 ¹ / ₂ (318)	11 ¹ / ₄ (286)	17 ¹ / ₂ (445)	20 (508)	22 ¹ / ₂ (573)	
Dry and water saturated concrete	Temperature range A ²	Characteristic bond strength in cracked concrete	$\tau_{k,cr}$	psi (MPa)	970 (6.7)	990 (6.8)	990 (6.8)	995 (6.9)	970 (6.7)	
		Characteristic bond strength in uncracked concrete	$\tau_{k,un-cr}$	psi (MPa)	1,720 (11.9)	1,690 (11.7)	1,670 (11.5)	1,640 (11.3)	1,620 (11.2)	
	Temperature range B ²	Characteristic bond strength in cracked concrete	$\tau_{k,cr}$	psi (MPa)	670 (4.6)	680 (4.7)	680 (4.7)	690 (4.8)	670 (4.6)	
		Characteristic bond strength in uncracked concrete	$\tau_{k,un-cr}$	psi (MPa)	1,190 (8.2)	1,170 (8.1)	1,150 (7.9)	1,130 (7.8)	1,120 (7.7)	
	Anchor Category			-	-	1	1	1	1	1
	Strength Reduction factor			ϕ_t, ϕ_{ws}	-	0.65	0.65	0.65	0.65	0.65
Reduction for seismic tension			$\alpha_{N,seis}$	-	0.9	0.9	0.9	0.9	0.9	

For SI: 1 inch ≅ 25.4 mm, 1 lbf = 4.448 N, 1 psi = 0.006897 MPa.

For pound-inch units: 1 mm = 0.03937 inches, 1 N = 0.2248 lbf, 1 MPa = 145.0 psi

¹Bond strength values correspond to concrete compressive strength in the range 2,500 psi ≤ f_c ≤ 8,000 psi [minimum of 24 MPa is required under ADIBC Appendix L, Section 5.1.1].

²Temperature range A: Maximum short term temperature = 130°F (55°C), Maximum long term temperature = 110°F (43°C).

Temperature range B: Maximum short term temperature = 176°F (80°C), Maximum long term temperature = 110°F (43°C).

Short term elevated concrete temperatures are those that occur over brief intervals, e.g., as a result of diurnal cycling. Long term concrete temperatures are roughly constant over significant periods of time.

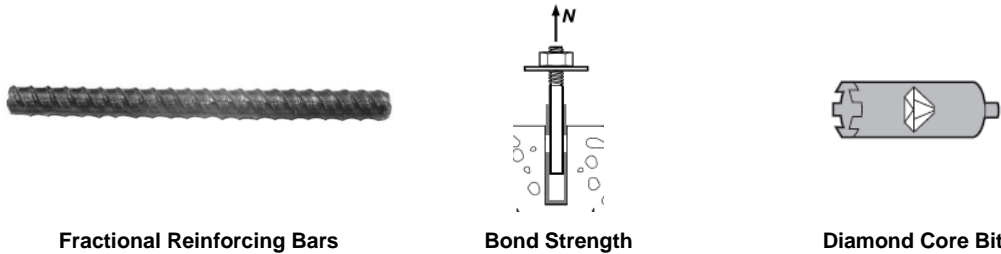

TABLE 10—BOND STRENGTH DESIGN INFORMATION FOR FRACTIONAL REINFORCING BARS IN HOLES CORE DRILLED WITH A DIAMOND CORE BIT¹

DESIGN INFORMATION			Symbol	Units	Nominal reinforcing bar size							
					#3	#4	#5	#6	#7	#8	#9	#10
Minimum Embedment			$h_{ef,min}$	in. (mm)	2 ³ / ₈ (60)	2 ³ / ₈ (60)	3 (76)	3 (76)	3 ³ / ₈ (85)	4 (102)	4 ¹ / ₂ (114)	5 (127)
Maximum Embedment			$h_{ef,max}$	in. (mm)	7 ¹ / ₂ (191)	10 (254)	12 ¹ / ₂ (318)	15 (381)	17 ¹ / ₂ (445)	20 (508)	22 ¹ / ₂ (572)	25 (635)
Dry and water saturated concrete	Temperature range A ²	Characteristic bond strength in uncracked concrete	$\tau_{k,un-cr}$	psi (MPa)	1,150 (8.0)	1,150 (8.0)	1,150 (8.0)	1,150 (8.0)	1,150 (8.0)	1,150 (8.0)	1,150 (8.0)	1,150 (8.0)
		Characteristic bond strength in uncracked concrete	$\tau_{k,un-cr}$	psi (MPa)	800 (5.5)	800 (5.5)	800 (5.5)	800 (5.5)	800 (5.5)	800 (5.5)	800 (5.5)	800 (5.5)
	Anchor Category			-	-	2	2	3	3	3	3	3
	Strength Reduction factor			ϕ_t, ϕ_{ws}	-	0.55	0.55	0.45	0.45	0.45	0.45	0.45

For SI: 1 inch ≅ 25.4 mm, 1 lbf = 4.448 N, 1 psi = 0.006897 MPa.

For pound-inch units: 1 mm = 0.03937 inches, 1 N = 0.2248 lbf, 1 MPa = 145.0 psi

¹Bond strength values correspond to concrete compressive strength f_c = 2,500 psi (17.2 MPa) [minimum of 24 MPa is required under ADIBC Appendix L, Section 5.1.1]. For concrete compressive strength, f_c, between 2,500 psi (17.2 MPa) and 8,000 psi (55.2 MPa), the tabulated characteristic bond strength may be increased by a factor of (f_c / 2,500)^{0.25} for uncracked concrete. [For SI: (f_c / 17.2)^{0.25}]. See Section 4.1.4 of this report for bond strength determination.

²Temperature range A: Maximum short term temperature = 130°F (55°C), Maximum long term temperature = 110°F (43°C).

Temperature range B: Maximum short term temperature = 176°F (80°C), Maximum long term temperature = 110°F (43°C).

Short term elevated concrete temperatures are those that occur over brief intervals, e.g., as a result of diurnal cycling. Long term concrete temperatures are roughly constant over significant periods of time.

喜利得股份有限公司

送審專用

FOR REVIEW



Fractional Threaded Rod

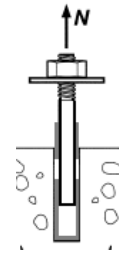

Bond Strength

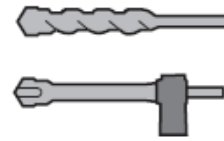

Carbide Bit or
Hilti Hollow Carbide Bit

TABLE 11—BOND STRENGTH DESIGN INFORMATION FOR FRACTIONAL THREADED ROD IN HOLES DRILLED WITH A HAMMER DRILL AND CARBIDE BIT (OR HILTI HOLLOW CARBIDE DRILL BIT)¹

DESIGN INFORMATION			Symbol	Units	Nominal rod diameter (in.)							
					3/8	1/2	5/8	3/4	7/8	1	1 1/4	
Minimum Embedment			$h_{ef,min}$	in. (mm)	2 3/8 (60)	2 3/4 (70)	3 1/8 (79)	3 1/2 (89)	3 1/2 (89)	4 (102)	5 (127)	
Maximum Embedment			$h_{ef,max}$	in. (mm)	7 1/2 (191)	10 (254)	12 1/2 (318)	15 (381)	17 1/2 (445)	20 (508)	25 (635)	
Dry concrete and Water Saturated Concrete	Temperature range A ²	Characteristic bond strength in cracked concrete	$\tau_{k,cr}$	psi (MPa)	1,280 (8.8)	1,270 (8.7)	1,260 (8.7)	1,250 (8.6)	1,240 (8.6)	1,240 (8.5)	1,180 (8.1)	
		Characteristic bond strength in uncracked concrete	$\tau_{k,uncr}$	psi (MPa)	2,380 (16.4)	2,300 (15.8)	2,210 (15.3)	2,130 (14.7)	2,040 (14.1)	1,960 (13.5)	1,790 (12.4)	
	Temperature range B ²	Characteristic bond strength in cracked concrete	$\tau_{k,cr}$	psi (MPa)	880 (6.1)	870 (6.0)	870 (6.0)	860 (5.9)	860 (5.9)	850 (5.9)	810 (5.6)	
		Characteristic bond strength in uncracked concrete	$\tau_{k,uncr}$	psi (MPa)	1,640 (11.3)	1,590 (10.9)	1,530 (10.5)	1,470 (10.1)	1,410 (9.7)	1,350 (9.3)	1,240 (8.5)	
	Anchor Category		-	-	-	1	1	1	1	1	1	1
	Strength Reduction factor		ϕ_d, ϕ_{ws}	ϕ_s, ϕ_{ws}	-	0.65	0.65	0.65	0.65	0.65	0.65	0.65
Water-filled hole	Temperature range A ²	Characteristic bond strength in cracked concrete	$\tau_{k,cr}$	psi (MPa)	940 (6.5)	940 (6.5)	940 (6.5)	940 (6.5)	940 (6.5)	950 (6.5)	920 (6.4)	
		Characteristic bond strength in uncracked concrete	$\tau_{k,uncr}$	psi (MPa)	1,760 (12.1)	1,700 (11.7)	1,660 (11.4)	1,600 (11.0)	1,550 (10.7)	1,500 (10.4)	1,400 (9.7)	
	Temperature range B ²	Characteristic bond strength in cracked concrete	$\tau_{k,cr}$	psi (MPa)	650 (4.5)	650 (4.5)	650 (4.5)	650 (4.5)	650 (4.5)	650 (4.5)	640 (4.4)	
		Characteristic bond strength in uncracked concrete	$\tau_{k,uncr}$	psi (MPa)	1,210 (8.4)	1,170 (8.1)	1,140 (7.9)	1,110 (7.6)	1,070 (7.4)	1,040 (7.1)	970 (6.7)	
	Anchor Category		-	-	-	3	3	3	3	3	3	3
	Strength Reduction factor		ϕ_{wf}	-	-	0.45	0.45	0.45	0.45	0.45	0.45	0.45
Submerged concrete	Temperature range A ²	Characteristic bond strength in cracked concrete	$\tau_{k,cr}$	psi (MPa)	820 (5.7)	830 (5.7)	830 (5.8)	840 (5.8)	850 (5.9)	860 (5.9)	860 (5.9)	
		Characteristic bond strength in uncracked concrete	$\tau_{k,uncr}$	psi (MPa)	1,530 (10.6)	1,500 (10.3)	1,470 (10.1)	1,430 (9.9)	1,400 (9.6)	1,370 (9.4)	1,300 (9.0)	
	Temperature range B ²	Characteristic bond strength in cracked concrete	$\tau_{k,cr}$	psi (MPa)	570 (3.9)	570 (3.9)	580 (4.0)	580 (4.0)	590 (4.0)	590 (4.1)	590 (4.1)	
		Characteristic bond strength in uncracked concrete	$\tau_{k,uncr}$	psi (MPa)	1,060 (7.3)	1,030 (7.1)	1,010 (7.0)	990 (6.8)	960 (6.6)	940 (6.5)	900 (6.2)	
	Anchor Category		-	-	-	3	3	3	3	3	3	3
	Strength Reduction factor		ϕ_{uw}	-	-	0.45	0.45	0.45	0.45	0.45	0.45	0.45
Reduction for seismic tension			$\alpha_{N,seis}$	-	0.92	0.93	0.95	1	1	1	1	

For SI: 1 inch ≅ 25.4 mm, 1 lbf = 4.448 N, 1 psi = 0.006897 MPa.

For pound-inch units: 1 mm = 0.03937 inches, 1 N = 0.2248 lbf, 1 MPa = 145.0 psi

¹Bond strength values correspond to concrete compressive strength $f_c = 2,500$ psi (17.2 MPa) [minimum of 24 MPa is required under ADIBC Appendix 1, Section 5.1.1]. For concrete compressive strength, f_c , between 2,500 psi (17.2 MPa) and 8,000 psi (55.2 MPa), the tabulated characteristic bond strength may be increased by a factor of $(f_c / 2,500)^{0.25}$ for uncracked concrete [For SI: $(f_c / 17.2)^{0.25}$] and $(f_c / 2,500)^{0.15}$ for cracked concrete [For SI: $(f_c / 17.2)^{0.15}$]. See Section 4.1.4 of this report for bond strength determination.

²Temperature range A: Maximum short term temperature = 130°F (55°C), Maximum long term temperature = 110°F (43°C).

Temperature range B: Maximum short term temperature = 176°F (80°C), Maximum long term temperature = 110°F (43°C).

Short term elevated concrete temperatures are those that occur over brief intervals, e.g., as a result of diurnal cycling. Long term concrete temperatures are roughly constant over significant periods of time.

喜利得股份有限公司
送審專用
FOR REVIEW

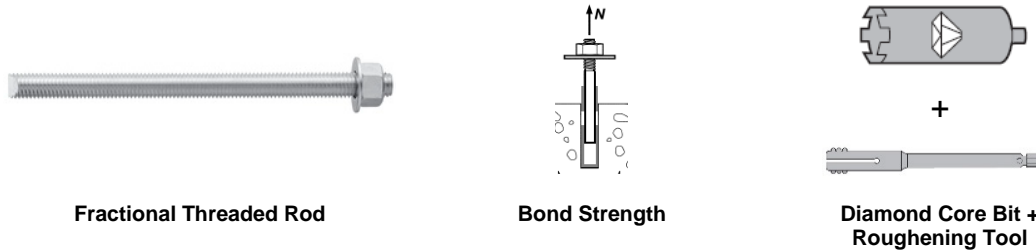

TABLE 12—BOND STRENGTH DESIGN INFORMATION FOR U.S. CUSTOMARY UNIT THREADED RODS IN HOLES CORE DRILLED WITH A DIAMOND CORE BIT AND ROUGHENED WITH A HILTI ROUGHENING TOOL¹

DESIGN INFORMATION			Symbol	Units	Nominal rod diameter (in.)					
					5/8	3/4	7/8	1	1 1/4	
Minimum Embedment			$h_{ef,min}$	in. (mm)	3 1/8 (79)	3 1/2 (89)	3 1/2 (89)	4 (102)	5 (127)	
Maximum Embedment			$h_{ef,max}$	in. (mm)	12 1/2 (318)	11 1/4 (286)	17 1/2 (445)	20 (508)	25 (635)	
Dry and water saturated concrete	Temperature range A ²	Characteristic bond strength in cracked concrete	$\tau_{k,cr}$	psi (MPa)	880 (6.1)	875 (6.0)	870 (6.0)	870 (6.0)	825 (5.7)	
		Characteristic bond strength in uncracked concrete	$\tau_{k,uncr}$	psi (MPa)	2,210 (15.3)	2,130 (14.7)	2,040 (14.1)	1,960 (13.5)	1,790 (12.4)	
	Temperature range B ²	Characteristic bond strength in cracked concrete	$\tau_{k,cr}$	psi (MPa)	610 (4.2)	605 (4.2)	605 (4.2)	600 (4.1)	570 (3.9)	
		Characteristic bond strength in uncracked concrete	$\tau_{k,uncr}$	psi (MPa)	1,530 (10.5)	1,470 (10.1)	1,410 (9.7)	1,350 (9.3)	1,240 (8.5)	
	Anchor Category			-	-	1	1	1	1	1
	Strength Reduction factor			ϕ_{dt}, ϕ_{ws}	-	0.65	0.65	0.65	0.65	0.65
Reduction for seismic tension			$\alpha_{N,seis}$	-	0.95	1	1	1	1	

For SI: 1 inch ≅ 25.4 mm, 1 lbf = 4.448 N, 1 psi = 0.006897 MPa.

For pound-inch units: 1 mm = 0.03937 inches, 1 N = 0.2248 lbf, 1 MPa = 145.0 psi

¹Bond strength values correspond to concrete compressive strength in the range 2,500 psi ≤ f_c ≤ 8,000 psi [minimum of 24 MPa is required under ADIBC Appendix L, Section 5.1.1].

²Temperature range A: Maximum short term temperature = 130°F (55°C), Maximum long term temperature = 110°F (43°C).

Temperature range B: Maximum short term temperature = 176°F (80°C), Maximum long term temperature = 110°F (43°C).

Short term elevated concrete temperatures are those that occur over brief intervals, e.g., as a result of diurnal cycling. Long term concrete temperatures are roughly constant over significant periods of time.

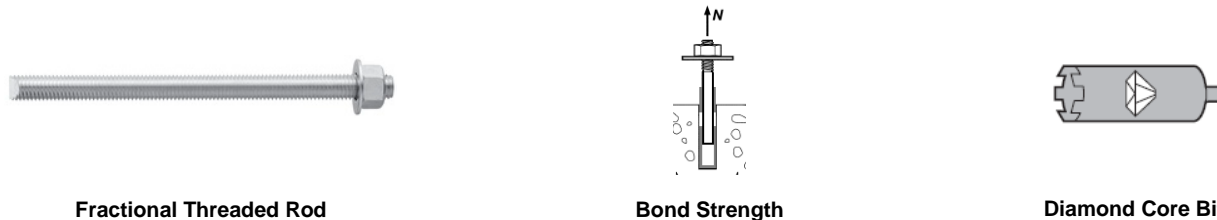

TABLE 13—BOND STRENGTH DESIGN INFORMATION FOR FRACTIONAL THREADED RODS IN HOLES CORE DRILLED WITH A DIAMOND CORE BIT¹

DESIGN INFORMATION			Symbol	Units	Nominal rod diameter (in.)						
					3/8	1/2	5/8	3/4	7/8	1	1 1/4
Minimum Embedment			$h_{ef,min}$	in. (mm)	2 3/8 (60)	2 3/4 (70)	3 1/8 (79)	3 1/2 (89)	3 1/2 (89)	4 (102)	5 (127)
Maximum Embedment			$h_{ef,max}$	in. (mm)	7 1/2 (191)	10 (254)	12 1/2 (318)	15 (381)	17 1/2 (445)	20 (508)	25 (635)
Dry concrete and water saturated concrete	Temperature range A ²	Characteristic bond strength in uncracked concrete	$\tau_{k,uncr}$	psi (MPa)	1,550 (10.7)	1,550 (10.7)	1,550 (10.7)	1,550 (10.7)	1,550 (10.7)	1,550 (10.7)	1,550 (10.7)
		Characteristic bond strength in uncracked concrete	$\tau_{k,uncr}$	psi (MPa)	1,070 (7.4)	1,070 (7.4)	1,070 (7.4)	1,070 (7.4)	1,070 (7.4)	1,070 (7.4)	1,070 (7.4)
	Anchor Category			-	-	2	2	3	3	3	3
	Strength Reduction factor			ϕ_{dt}, ϕ_{ws}	-	0.55	0.55	0.45	0.45	0.45	0.45

For SI: 1 inch ≅ 25.4 mm, 1 lbf = 4.448 N, 1 psi = 0.006897 MPa.

For pound-inch units: 1 mm = 0.03937 inches, 1 N = 0.2248 lbf, 1 MPa = 145.0 psi

¹Bond strength values correspond to concrete compressive strength f_c = 2,500 psi (17.2 MPa) [minimum of 24 MPa is required under ADIBC Appendix L, Section 5.1.1]. For concrete compressive strength, f_c, between 2,500 psi (17.2 MPa) and 8,000 psi (55.2 MPa), the tabulated characteristic bond strength may be increased by a factor of (f_c / 2,500)^{0.25} for uncracked concrete [For SI: (f_c / 17.2)^{0.25}]. See Section 4.1.4 of this report for bond strength determination.

²Temperature range A: Maximum short term temperature = 130°F (55°C), Maximum long term temperature = 110°F (43°C).

Temperature range B: Maximum short term temperature = 176°F (80°C), Maximum long term temperature = 110°F (43°C).

Short term elevated concrete temperatures are those that occur over brief intervals, e.g., as a result of diurnal cycling. Long term concrete temperatures are roughly constant over significant periods of time.

喜利得股份有限公司
送審專用
FOR REVIEW



TABLE 14—STEEL DESIGN INFORMATION FOR METRIC THREADED ROD AND EU METRIC REINFORCING BARS

DESIGN INFORMATION		Symbol	Units	Nominal rod diameter (mm) ¹								
				8	10	12	16	20	24	27	30	
Rod Outside Diameter		<i>d</i>	mm (in.)	8 (0.31)	10 (0.39)	12 (0.47)	16 (0.63)	20 (0.79)	24 (0.94)	27 (1.06)	30 (1.18)	
Rod effective cross-sectional area		<i>A_{se}</i>	mm ² (in. ²)	36.6 (0.057)	58.0 (0.090)	84.3 (0.131)	157 (0.243)	245 (0.380)	353 (0.547)	459 (0.711)	561 (0.870)	
ISO 898-1 Class 5.8	Nominal strength as governed by steel strength	<i>N_{sa}</i>	kN (lb)	18.3 (4,114)	29.0 (6,519)	42.0 (9,476)	78.5 (17,647)	122.5 (27,539)	176.5 (39,679)	229.5 (51,594)	280.5 (63,059)	
		<i>V_{sa}</i>	kN (lb)	11.0 (2,648)	14.5 (3,260)	25.5 (5,685)	47.0 (10,588)	73.5 (16,523)	106.0 (23,807)	137.5 (30,956)	168.5 (37,835)	
	Reduction for seismic shear	$\alpha_{V,seis}$	-	1.00								
	Strength reduction factor for tension ²	ϕ	-	0.65								
	Strength reduction factor for shear ²	ϕ	-	0.60								
ISO 898-1 Class 8.8	Nominal strength as governed by steel strength	<i>N_{sa}</i>	kN (lb)	29.3 (6,582)	46.5 (10,431)	67.5 (15,161)	125.5 (28,236)	196.0 (44,063)	282.5 (63,486)	367.0 (82,550)	449.0 (100,894)	
		<i>V_{sa}</i>	kN (lb)	17.6 (3,949)	23.0 (5,216)	40.5 (9,097)	75.5 (16,942)	117.5 (26,438)	169.5 (38,092)	220.5 (49,530)	269.5 (60,537)	
	Reduction for seismic shear	$\alpha_{V,seis}$	-	1.00								
	Strength reduction factor for tension ²	ϕ	-	0.65								
	Strength reduction factor for shear ²	ϕ	-	0.60								
ISO 3506-1 Class A4 Stainless ³	Nominal strength as governed by steel strength	<i>N_{sa}</i>	kN (lb)	25.6 (5,760)	40.6 (9,127)	59.0 (13,266)	109.9 (24,706)	171.5 (38,555)	247.1 (55,550)	229.5 (51,594)	280.5 (63,059)	
		<i>V_{sa}</i>	kN (lb)	15.4 (3,456)	20.3 (4,564)	35.4 (7,960)	65.9 (14,824)	102.9 (23,133)	148.3 (33,330)	137.7 (30,956)	168.3 (37,835)	
	Reduction for seismic shear	$\alpha_{V,seis}$	-	0.80								
	Strength reduction factor for tension ²	ϕ	-	0.65								
	Strength reduction factor for shear ²	ϕ	-	0.60								
DESIGN INFORMATION		Symbol	Units	Nominal reinforcing bar diameter (mm)								
Nominal bar diameter		<i>d</i>	mm (in.)	10.0 (0.394)	12.0 (0.472)	14.0 (0.551)	16.0 (0.630)	20.0 (0.787)	25.0 (0.984)	28.0 (1.102)	30.0 (1.224)	32.0 (1.260)
Bar effective cross-sectional area		<i>A_{se}</i>	mm ² (in. ²)	78.5 (0.122)	113.1 (0.175)	153.9 (0.239)	201.1 (0.312)	314.2 (0.487)	490.9 (0.761)	615.8 (0.954)	706.9 (1.096)	804.2 (1.247)
DIN 488 BSt 550/500	Nominal strength as governed by steel strength	<i>N_{sa}</i>	kN (lb)	43.0 (9,711)	62.0 (13,984)	84.5 (19,034)	110.5 (24,860)	173.0 (38,844)	270.0 (60,694)	338.5 (76,135)	388.8 (87,406)	442.5 (99,441)
		<i>V_{sa}</i>	kN (lb)	26.0 (5,827)	37.5 (8,390)	51.0 (11,420)	66.5 (14,916)	103.0 (23,307)	162.0 (36,416)	203.0 (45,681)	233.3 (52,444)	265.5 (59,665)
	Reduction for seismic shear	$\alpha_{V,seis}$	-	0.70								
	Strength reduction factor for tension ²	ϕ	-	0.65								
	Strength reduction factor for shear ²	ϕ	-	0.60								

¹ Values provided for common rod material types are based on specified strengths and calculated in accordance with ACI 318-14 Eq. (17.4.1.2) or Eq. (17.4.1.3) of ACI 318-14, as applicable. Nuts and washers must be appropriate for the rod.

² For use with the load combinations of IBC Section 1605.2, ACI 318-14 5.3, or ACI 318-11 9.2, as applicable, as set forth in ACI 318-14 17.3.3 or ACI 318 D.4.3, as applicable. If the load combinations of ACI 318-11 Appendix C are used, the appropriate value of ϕ must be determined in accordance with ACI 318-11 D.4.3.

³ A4-70 Stainless (M8- M24); A4-502 Stainless (M27- M30)

喜利得股份有限公司

送審專用

FOR REVIEW



Metric Threaded Rod and EU Metric Reinforcing Bars

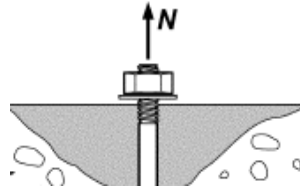

Concrete Breakout Strength

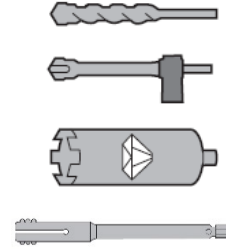

Carbide Bit or Hilti Hollow Carbide Bit Diamond Core Bit + Roughening Tool, or Diamond Core Bit

TABLE 15—CONCRETE BREAKOUT DESIGN INFORMATION FOR METRIC THREADED ROD AND EU METRIC REINFORCING BARS ALL DRILLING METHODS¹

DESIGN INFORMATION	Symbol	Units	Nominal rod diameter (mm)								
			8	10	12	16	20	24	27	30	
Minimum Embedment	$h_{ef,min}$	mm (in.)	60 (2.4)	60 (2.4)	70 (2.8)	80 (3.1)	90 (3.5)	100 (3.9)	110 (4.3)	120 (4.7)	
Maximum Embedment	$h_{ef,max}$	mm (in.)	160 (6.3)	200 (7.9)	240 (9.4)	320 (12.6)	400 (15.7)	480 (18.9)	540 (21.4)	600 (23.7)	
Min. anchor spacing ³	s_{min}	mm (in.)	40 (1.6)	50 (2.0)	60 (2.4)	80 (3.2)	100 (3.9)	120 (4.7)	135 (5.3)	150 (5.9)	
Min. edge distance ³	c_{min}	-	5d; or see Section 4.1.9 of this report for design with reduced minimum edge distances								
Minimum concrete thickness	h_{min}	mm (in.)	$h_{ef} + 30$ ($h_{ef} + 1\frac{1}{4}$)			$h_{ef} + 2d_o^{(4)}$					
DESIGN INFORMATION	Symbol	Units	Nominal reinforcing bar diameter (mm)								
			10	12	14	16	20	25	28	30	32
Minimum Embedment	$h_{ef,min}$	mm (in.)	60 (2.4)	70 (2.8)	80 (3.1)	80 (3.1)	90 (3.5)	100 (3.9)	112 (4.4)	120 (4.7)	128 (5.0)
Maximum Embedment	$h_{ef,max}$	mm (in.)	200 (7.9)	240 (9.4)	280 (11.0)	320 (12.6)	400 (15.7)	500 (19.7)	560 (22.0)	600 (23.7)	640 (25.2)
Min. anchor spacing ³	s_{min}	mm (in.)	50 (2.0)	60 (2.4)	70 (2.8)	80 (3.2)	100 (3.9)	125 (4.9)	140 (5.5)	150 (5.9)	160 (6.3)
Min. edge distance ³	c_{min}	-	5d; or see Section 4.1.9 of this report for design with reduced minimum edge distances								
Minimum concrete thickness	h_{min}	mm (in.)	$h_{ef} + 30$ ($h_{ef} + 1\frac{1}{4}$)			$h_{ef} + 2d_o^{(4)}$					
Critical edge distance – splitting (for uncracked concrete)	c_{ac}	-	See Section 4.1.10 of this report.								
Effectiveness factor for cracked concrete	$k_{c,cr}$	SI (in-lb)	7.1 (17)								
Effectiveness factor for uncracked concrete	$k_{c,uncr}$	SI (in-lb)	10 (24)								
Strength reduction factor for tension, concrete failure modes, Condition B ²	ϕ	-	0.65								
Strength reduction factor for shear, concrete failure modes, Condition B ²	ϕ	-	0.70								

For SI: 1 inch = 25.4 mm, 1 lbf = 4.448 N, 1 psi = 0.006897 MPa.
For pound-inch units: 1 mm = 0.03937 inches, 1 N = 0.2248 lbf, 1 MPa = 145.0 psi

¹Additional setting information is described in Figure 9A and 9B, Manufacturers Printed Installation Instructions (MPII).
²Values provided for post-installed anchors installed under Condition B without supplementary reinforcement as defined in ACI 318-14 17.3.3 or ACI 318-11 D.4.3.
³For installations with 1³/₄-inch edge distance, refer to Section 4.1.9 for spacing and maximum torque requirements.
⁴ d_o = hole diameter.

喜利得股份有限公司

送審專用

FOR REVIEW

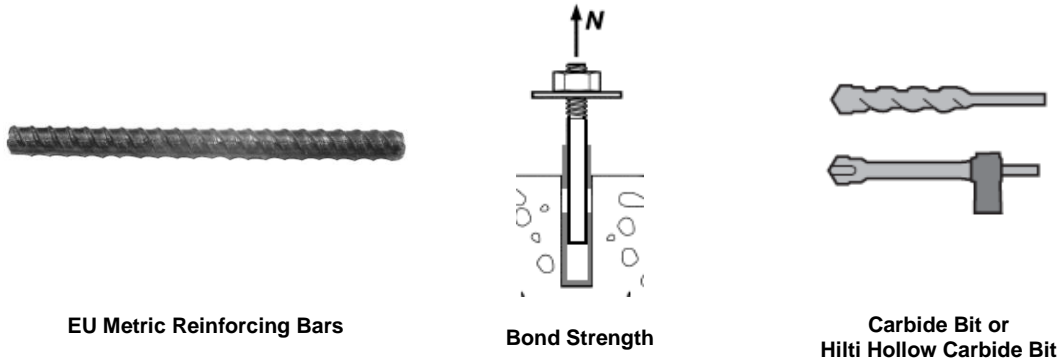

TABLE 16—BOND STRENGTH DESIGN INFORMATION FOR EU METRIC REINFORCING BARS IN HOLES DRILLED WITH A HAMMER DRILL AND CARBIDE BIT (OR HILTI HOLLOW CARBIDE DRILL BIT)¹

DESIGN INFORMATION			Symbol	Units	Nominal reinforcing bar diameter (mm)									
					10	12	14	16	20	25	28	30	32	
Minimum Embedment			$h_{ef,min}$	mm (in.)	60 (2.4)	70 (2.8)	80 (3.1)	80 (3.1)	90 (3.5)	100 (3.9)	112 (4.4)	120 (4.7)	128 (5.0)	
Maximum Embedment			$h_{ef,max}$	mm (in.)	200 (7.9)	240 (9.4)	280 (11.0)	320 (12.6)	400 (15.7)	500 (19.7)	560 (22.0)	600 (23.7)	640 (25.2)	
Dry concrete and Water saturated concrete	Temperature range A ²	Characteristic bond strength in cracked concrete	$\tau_{k,cr}$	MPa (psi)	9.3 (1,350)	9.4 (1,360)	9.5 (1,380)	9.6 (1,390)	9.7 (1,410)	9.8 (1,420)	9.7 (1,400)	9.5 (1,370)	9.3 (1,350)	
		Characteristic bond strength in uncracked concrete	$\tau_{k,uncr}$	MPa (psi)	12.2 (1,770)	12.1 (1,750)	12.0 (1,730)	11.8 (1,720)	11.6 (1,690)	11.4 (1,650)	11.2 (1,620)	11.1 (1,610)	11.0 (1,590)	
	Temperature range B ²	Characteristic bond strength in cracked concrete	$\tau_{k,cr}$	MPa (psi)	6.4 (930)	6.5 (940)	6.5 (950)	6.6 (960)	6.7 (970)	6.8 (980)	6.7 (970)	6.5 (950)	6.4 (930)	
		Characteristic bond strength in uncracked concrete	$\tau_{k,uncr}$	MPa (psi)	8.4 (1,220)	8.3 (1,210)	8.3 (1,200)	8.2 (1,190)	8.0 (1,160)	7.8 (1,140)	7.7 (1,120)	7.7 (1,110)	7.6 (1,100)	
	Anchor Category			-	-	1	1	1	1	1	1	1	1	1
	Strength Reduction factor			ϕ_{ct}, ϕ_{ws}	-	0.65	0.65	0.65	0.65	0.65	0.65	0.65	0.65	0.65
Water-filled hole	Temperature range A ²	Characteristic bond strength in cracked concrete	$\tau_{k,cr}$	MPa (psi)	6.9 (1,000)	6.9 (1,010)	7.0 (1,020)	7.2 (1,040)	7.4 (1,070)	7.4 (1,080)	7.4 (1,080)	7.4 (1,070)	7.2 (1,050)	
		Characteristic bond strength in uncracked concrete	$\tau_{k,uncr}$	MPa (psi)	9.0 (1,310)	8.9 (1,300)	8.9 (1,280)	8.9 (1,280)	8.8 (1,270)	8.7 (1,250)	8.7 (1,250)	8.6 (1,250)	8.6 (1,240)	
	Temperature range B ²	Characteristic bond strength in cracked concrete	$\tau_{k,cr}$	MPa (psi)	4.7 (690)	4.8 (700)	4.8 (700)	5.0 (720)	5.1 (740)	5.1 (740)	5.1 (740)	5.1 (740)	5.0 (720)	
		Characteristic bond strength in uncracked concrete	$\tau_{k,uncr}$	MPa (psi)	6.2 (900)	6.2 (890)	6.1 (890)	6.1 (890)	6.1 (880)	6.0 (870)	5.9 (860)	5.9 (860)	5.9 (860)	
	Anchor Category			-	-	3	3	3	3	3	3	3	3	3
	Strength Reduction factor			ϕ_{wf}	-	0.45	0.45	0.45	0.45	0.45	0.45	0.45	0.45	0.45
Submerged concrete	Temperature range A ²	Characteristic bond strength in cracked concrete	$\tau_{k,cr}$	MPa (psi)	6.0 (880)	6.1 (890)	6.2 (890)	6.3 (920)	6.6 (960)	6.8 (980)	6.8 (980)	6.8 (990)	6.8 (980)	
		Characteristic bond strength in uncracked concrete	$\tau_{k,uncr}$	MPa (psi)	7.9 (1,140)	7.8 (1,140)	7.8 (1,130)	7.8 (1,140)	7.9 (1,140)	7.8 (1,140)	7.9 (1,140)	8.0 (1,150)	8.0 (1,160)	
	Temperature range B ²	Characteristic bond strength in cracked concrete	$\tau_{k,cr}$	MPa (psi)	4.2 (600)	4.2 (610)	4.3 (620)	4.4 (630)	4.6 (660)	4.7 (680)	4.7 (680)	4.7 (680)	4.7 (680)	
		Characteristic bond strength in uncracked concrete	$\tau_{k,uncr}$	MPa (psi)	5.4 (790)	5.4 (780)	5.4 (780)	5.4 (790)	5.4 (790)	5.4 (780)	5.4 (790)	5.5 (800)	5.5 (800)	
	Anchor Category			-	-	3	3	3	3	3	3	3	3	3
	Strength Reduction factor			ϕ_{uw}	-	0.45	0.45	0.45	0.45	0.45	0.45	0.45	0.45	0.45
Reduction for seismic tension			$\alpha_{N,seis}$	-	0.9	0.9	0.9	0.9	0.9	0.9	0.9	0.9	0.9	

For SI: 1 inch \approx 25.4 mm, 1 lbf = 4.448 N, 1 psi = 0.006897 MPa.
For pound-inch units: 1 mm = 0.03937 inches, 1 N = 0.2248 lbf, 1 MPa = 145.0 psi

¹Bond strength values correspond to concrete compressive strength $f_c = 2,500$ psi (17.2 MPa) [minimum of 24 MPa is required under ADIBC Appendix L, Section 5.1.1]. For concrete compressive strength, f_c , between 2,500 psi (17.2 MPa) and 8,000 psi (55.2 MPa), the tabulated characteristic bond strength may be increased by a factor of $(f_c / 2,500)^{0.25}$ for uncracked concrete [For SI: $(f_c / 17.2)^{0.25}$] and $(f_c / 2,500)^{0.15}$ for cracked concrete [For SI: $(f_c / 17.2)^{0.15}$]. See Section 4.1.4 of this report for bond strength determination.

²Temperature range A: Maximum short term temperature = 130°F (55°C), Maximum long term temperature = 110°F (43°C).

Temperature range B: Maximum short term temperature = 176°F (80°C), Maximum long term temperature = 110°F (43°C).

Short term elevated concrete temperatures are those that occur over brief intervals, e.g., as a result of diurnal cycling. Long term concrete temperatures are roughly constant over significant periods of time.

送審專用

FOR REVIEW

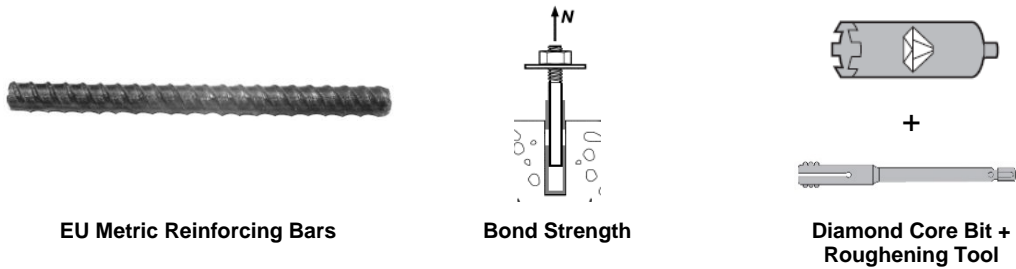

TABLE 17—BOND STRENGTH DESIGN INFORMATION FOR EU METRIC REINFORCING BARS IN HOLES CORE DRILLED WITH A DIAMOND CORE BIT AND ROUGHENED WITH A HILTI ROUGHENING TOOL¹

DESIGN INFORMATION			Symbol	Units	Nominal reinforcing bar diameter (mm)				
					14	16	20	25	28
Minimum Embedment			$h_{ef,min}$	mm (in.)	80 (3.1)	80 (3.1)	90 (3.5)	100 (3.9)	112 (4.4)
Maximum Embedment			$h_{ef,max}$	mm (in.)	280 (11.0)	320 (12.6)	400 (15.7)	500 (19.7)	560 (22.0)
Dry and water saturated concrete	Temperature range A ²	Characteristic bond strength in cracked concrete	$\tau_{k,cr}$	MPa (psi)	6.7 (965)	6.7 (970)	6.8 (985)	6.9 (995)	6.8 (980)
		Characteristic bond strength in uncracked concrete	$\tau_{k,uncr}$	MPa (psi)	12.0 (1,730)	11.8 (1,720)	11.6 (1,690)	11.4 (1,650)	11.2 (1,620)
	Temperature range B ²	Characteristic bond strength in cracked concrete	$\tau_{k,cr}$	MPa (psi)	4.6 (665)	4.6 (670)	4.7 (680)	4.8 (685)	4.7 (680)
		Characteristic bond strength in uncracked concrete	$\tau_{k,uncr}$	MPa (psi)	8.3 (1,200)	8.2 (1,190)	8.0 (1,160)	7.8 (1,140)	7.7 (1,120)
	Anchor Category		-	-	1	1	1	1	1
	Strength Reduction factor		ϕ_d, ϕ_{ws}	-	0.65	0.65	0.65	0.65	0.65
Reduction for seismic tension			$\alpha_{N,seis}$	-	0.9	0.9	0.9	0.9	0.9

For SI: 1 inch = 25.4 mm, 1 lbf = 4.448 N, 1 psi = 0.006897 MPa.
 For pound-inch units: 1 mm = 0.03937 inches, 1 N = 0.2248 lbf, 1 MPa = 145.0 psi

¹Bond strength values correspond to concrete compressive strength in the range 2,500 psi ≤ f_c ≤ 8,000 psi [minimum of 24 MPa is required under ADIBC Appendix L, Section 5.1.1].
²Temperature range A: Maximum short term temperature = 130°F (55°C), Maximum long term temperature = 110°F (43°C).
 Temperature range B: Maximum short term temperature = 176°F (80°C), Maximum long term temperature = 110°F (43°C).
 Short term elevated concrete temperatures are those that occur over brief intervals, e.g., as a result of diurnal cycling. Long term concrete temperatures are roughly constant over significant periods of time.

喜利得股份有限公司
 送審專用
 FOR REVIEW

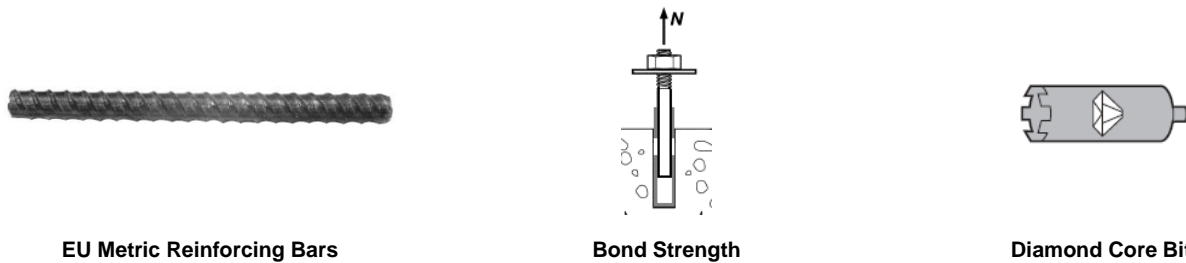

TABLE 18—BOND STRENGTH DESIGN INFORMATION FOR EU METRIC REINFORCING BARS IN HOLES CORE DRILLED WITH A DIAMOND CORE BIT¹

DESIGN INFORMATION			Symbol	Units	Nominal reinforcing bar diameter (mm)								
					10	12	14	16	20	25	28	30	32
Minimum Embedment			$h_{ef,min}$	mm (in.)	60 (2.4)	70 (2.8)	80 (3.1)	80 (3.1)	90 (3.5)	100 (3.9)	112 (4.4)	120 (4.7)	128 (5.0)
Maximum Embedment			$h_{ef,max}$	mm (in.)	200 (7.9)	240 (9.4)	280 (11.0)	320 (12.6)	400 (15.7)	500 (19.7)	560 (22.0)	600 (23.7)	640 (25.2)
Dry and Water Saturated concrete	Temperature range A ²	Characteristic bond strength in uncracked concrete	$\tau_{k,uncr}$	MPa (psi)	8.0 (1,150)	8.0 (1,150)	8.0 (1,150)	8.0 (1,150)	8.0 (1,150)	8.0 (1,150)	8.0 (1,150)	8.0 (1,150)	8.0 (1,150)
	Temperature range B ²	Characteristic bond strength in uncracked concrete	$\tau_{k,uncr}$	MPa (psi)	5.5 (800)	5.5 (800)	5.5 (800)	5.5 (800)	5.5 (800)	5.5 (800)	5.5 (800)	5.5 (800)	5.5 (800)
	Anchor Category		-		2	2	2	3	3	3	3	3	3
	Strength Reduction factor		ϕ_t, ϕ_{ws}		0.55	0.55	0.55	0.45	0.45	0.45	0.45	0.45	0.45

For SI: 1 inch ≅ 25.4 mm, 1 lbf = 4.448 N, 1 psi = 0.006897 MPa.
 For pound-inch units: 1 mm = 0.03937 inches, 1 N = 0.2248 lbf, 1 MPa = 145.0 psi

¹Bond strength values correspond to concrete compressive strength $f'_c = 2,500$ psi (17.2 MPa) [minimum of 24 MPa is required under ADIBC Appendix L, Section 5.1.1]. For concrete compressive strength, f'_c , between 2,500 psi (17.2 MPa) and 8,000 psi (55.2 MPa), the tabulated characteristic bond strength may be increased by a factor of $(f'_c / 2,500)^{0.25}$ for uncracked concrete [For SI: $(f'_c / 17.2)^{0.25}$]. See Section 4.1.4 of this report for bond strength determination.

²Temperature range A: Maximum short term temperature = 130°F (55°C), Maximum long term temperature = 110°F (43°C).

Temperature range B: Maximum short term temperature = 176°F (80°C), Maximum long term temperature = 110°F (43°C).

Short term elevated concrete temperatures are those that occur over brief intervals, e.g., as a result of diurnal cycling. Long term concrete temperatures are roughly constant over significant periods of time.

喜利得股份有限公司

送審專用

FOR REVIEW

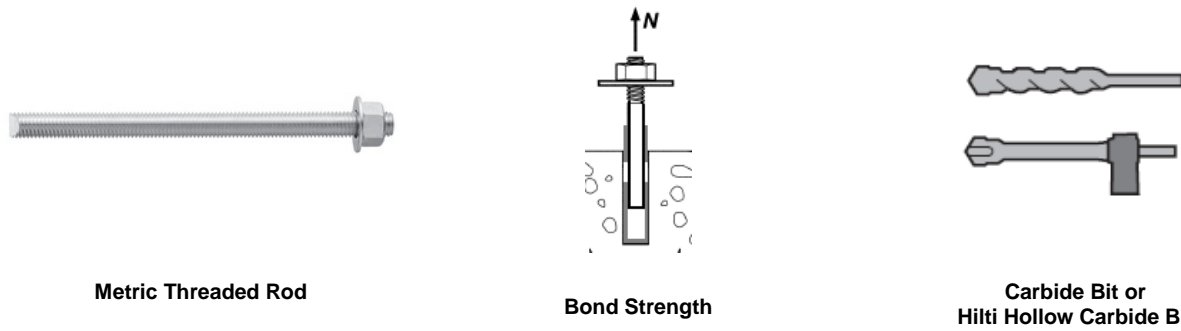

TABLE 19—BOND STRENGTH DESIGN INFORMATION FOR METRIC THREADED RODS IN HOLES DRILLED WITH A HAMMER DRILL AND CARBIDE BIT (OR HILTI HOLLOW CARBIDE DRILL BIT)¹

DESIGN INFORMATION		Symbol	Units	Nominal rod diameter (mm)								
				8	10	12	16	20	24	27	30	
Minimum Embedment		$h_{ef,min}$	mm (in.)	60 (2.4)	60 (2.4)	70 (2.8)	80 (3.1)	90 (3.5)	100 (3.9)	110 (4.3)	120 (4.7)	
Maximum Embedment		$h_{ef,max}$	mm (in.)	160 (6.3)	200 (7.9)	240 (9.4)	320 (12.6)	400 (15.7)	480 (18.9)	540 (21.4)	600 (23.7)	
Dry and Water Saturated Concrete	Temperature range A ²	Characteristic bond strength in cracked concrete	$\tau_{k,cr}$	MPa (psi)	8.8 (1,280)	8.8 (1,280)	8.8 (1,270)	8.7 (1,260)	8.6 (1,250)	8.5 (1,240)	8.5 (1,230)	8.4 (1,220)
		Characteristic bond strength in uncracked concrete	$\tau_{k,uncr}$	MPa (psi)	16.7 (2,420)	16.3 (2,370)	16.0 (2,320)	15.2 (2,210)	14.5 (2,100)	13.8 (2,000)	13.2 (1,920)	12.7 (1,840)
	Temperature range B ²	Characteristic bond strength in cracked concrete	$\tau_{k,cr}$	MPa (psi)	6.1 (890)	6.1 (880)	6.0 (880)	6.0 (870)	5.9 (860)	5.9 (860)	5.9 (850)	5.8 (840)
		Characteristic bond strength in uncracked concrete	$\tau_{k,uncr}$	MPa (psi)	11.5 (1,670)	11.3 (1,630)	11.0 (1,600)	10.5 (1,520)	10.0 (1,450)	9.5 (1,380)	9.1 (1,320)	8.7 (1,270)
	Anchor Category		-	-	1	1	1	1	1	1	1	1
	Strength Reduction factor		ϕ_t, ϕ_{vs}	-	0.65	0.65	0.65	0.65	0.65	0.65	0.65	0.65
Water-filled hole	Temperature range A ²	Characteristic bond strength in cracked concrete	$\tau_{k,cr}$	MPa (psi)	6.5 (940)	6.5 (940)	6.5 (940)	6.5 (940)	6.5 (940)	6.5 (940)	6.5 (950)	6.5 (950)
		Characteristic bond strength in uncracked concrete	$\tau_{k,uncr}$	MPa (psi)	12.3 (1,780)	12.1 (1,750)	11.8 (1,710)	11.4 (1,650)	11.0 (1,590)	10.5 (1,520)	10.2 (1,470)	9.8 (1,430)
	Temperature range B ²	Characteristic bond strength in cracked concrete	$\tau_{k,cr}$	MPa (psi)	4.5 (650)	4.5 (650)	4.5 (650)	4.5 (650)	4.5 (650)	4.5 (650)	4.5 (650)	4.5 (650)
		Characteristic bond strength in uncracked concrete	$\tau_{k,uncr}$	MPa (psi)	8.5 (1,230)	8.3 (1,210)	8.2 (1,180)	7.9 (1,140)	7.6 (1,100)	7.2 (1,050)	7.0 (1,020)	6.8 (990)
	Anchor Category		-	-	3	3	3	3	3	3	3	3
	Strength Reduction factor		ϕ_{wt}	-	0.45	0.45	0.45	0.45	0.45	0.45	0.45	0.45
Submerged concrete	Temperature range A ²	Characteristic bond strength in cracked concrete	$\tau_{k,cr}$	MPa (psi)	5.7 (820)	5.7 (820)	5.7 (830)	5.7 (830)	5.8 (840)	5.9 (860)	6.0 (870)	6.0 (870)
		Characteristic bond strength in uncracked concrete	$\tau_{k,uncr}$	MPa (psi)	10.7 (1,550)	10.5 (1,530)	10.4 (1,500)	10.1 (1,460)	9.8 (1,420)	9.5 (1,380)	9.3 (1,350)	9.1 (1,320)
	Temperature range B ²	Characteristic bond strength in cracked concrete	$\tau_{k,cr}$	MPa (psi)	3.9 (570)	3.9 (570)	3.9 (570)	4.0 (580)	4.0 (580)	4.1 (590)	4.1 (600)	4.2 (600)
		Characteristic bond strength in uncracked concrete	$\tau_{k,uncr}$	MPa (psi)	7.4 (1,070)	7.3 (1,060)	7.2 (1,040)	7.0 (1,010)	6.8 (980)	6.6 (950)	6.4 (930)	6.3 (910)
	Anchor Category		-	-	3	3	3	3	3	3	3	3
	Strength Reduction factor		ϕ_{uw}	-	0.45	0.45	0.45	0.45	0.45	0.45	0.45	0.45
Reduction for seismic tension		$\alpha_{N,seis}$	-	1	0.92	0.93	0.95	1	1	1	1	

For SI: 1 inch ≅ 25.4 mm, 1 lbf = 4.448 N, 1 psi = 0.006897 MPa.
 For pound-inch units: 1 mm = 0.03937 inches, 1 N = 0.2248 lbf, 1 MPa = 145.0 psi

¹Bond strength values correspond to concrete compressive strength $f'_c = 2,500$ psi (17.2 MPa) [minimum of 24 MPa is required under ADIBC Appendix L, Section 5.1.1]. For concrete compressive strength, f'_c , between 2,500 psi (17.2 MPa) and 8,000 psi (55.2 MPa), the tabulated characteristic bond strength may be increased by a factor of $(f'_c / 2,500)^{0.25}$ for uncracked concrete [For SI: $(f'_c / 17.2)^{0.25}$] and $(f'_c / 2,500)^{0.15}$ for cracked concrete [For SI: $(f'_c / 17.2)^{0.15}$]. See Section 4.1.4 of this report for bond strength determination.

²Temperature range A: Maximum short term temperature = 130°F (55°C), Maximum long term temperature = 110°F (43°C).
 Temperature range B: Maximum short term temperature = 176°F (80°C), Maximum long term temperature = 110°F (43°C).
 Short term elevated concrete temperatures are those that occur over brief intervals, e.g., as a result of diurnal cycling. Long term concrete temperatures are roughly constant over significant periods of time.

善利得股份有限公司
 送審專用
 FOR REVIEW



TABLE 20—BOND STRENGTH DESIGN INFORMATION FOR METRIC THREADED RODS IN HOLES CORE DRILLED WITH A DIAMOND CORE BIT AND ROUGHENED WITH A HILTI ROUGHENING TOOL¹

DESIGN INFORMATION			Symbol	Units	Nominal rod diameter (mm)					
					16	20	24	27	30	
Minimum Embedment			$h_{ef,min}$	mm (in.)	80 (3.1)	90 (3.5)	100 (3.9)	110 (4.3)	120 (4.7)	
Maximum Embedment			$h_{ef,max}$	mm (in.)	320 (12.6)	400 (15.7)	480 (18.9)	540 (21.4)	600 (23.7)	
Dry and water saturated concrete	Temperature range A ²	Characteristic bond strength in cracked concrete	$\tau_{k,cr}$	MPa (psi)	6.1 (880)	6.0 (875)	6.0 (870)	6.0 (860)	5.9 (855)	
		Characteristic bond strength in uncracked concrete	$\tau_{k,uncr}$	MPa (psi)	15.2 (2,210)	14.5 (2,100)	13.8 (2,000)	13.2 (1,920)	12.7 (1,840)	
	Temperature range B ²	Characteristic bond strength in cracked concrete	$\tau_{k,cr}$	MPa (psi)	4.2 (610)	4.2 (605)	4.2 (600)	4.2 (595)	4.1 (590)	
		Characteristic bond strength in uncracked concrete	$\tau_{k,uncr}$	MPa (psi)	10.5 (1,520)	10.0 (1,450)	9.5 (1,385)	9.1 (1,320)	8.7 (1,270)	
	Anchor Category			-	-	1	1	1	1	1
	Strength Reduction factor			ϕ_c, ϕ_{ws}	-	0.65	0.65	0.65	0.65	0.65
Reduction for seismic tension			$\alpha_{N,seis}$	-	0.95	1	1	1	1	

For SI: 1 inch ≅ 25.4 mm, 1 lbf = 4.448 N, 1 psi = 0.006897 MPa.
 For pound-inch units: 1 mm = 0.03937 inches, 1 N = 0.2248 lbf, 1 MPa = 145.0 psi

¹Bond strength values correspond to concrete compressive strength in the range 2,500 psi ≤ f_c ≤ 8,000 psi [minimum of 24 MPa is required under ADIBC Appendix L, Section 5.1.1].
²Temperature range A: Maximum short term temperature = 130°F (55°C), Maximum long term temperature = 110°F (43°C).
 Temperature range B: Maximum short term temperature = 176°F (80°C), Maximum long term temperature = 110°F (43°C).
 Short term elevated concrete temperatures are those that occur over brief intervals, e.g., as a result of diurnal cycling. Long term concrete temperatures are roughly constant over significant periods of time.

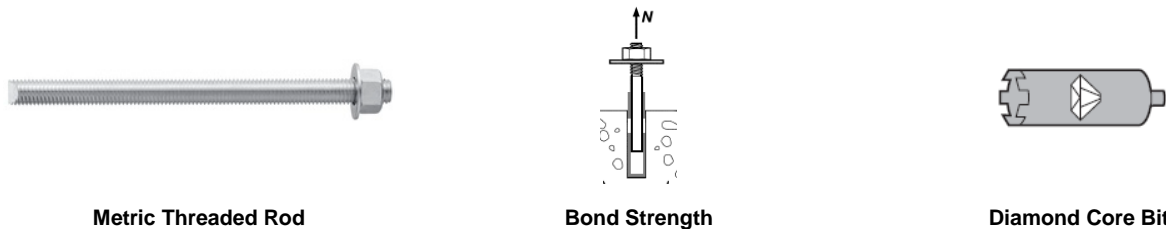

TABLE 21—BOND STRENGTH DESIGN INFORMATION FOR METRIC THREADED RODS IN HOLES CORE DRILLED WITH A DIAMOND CORE BIT¹

DESIGN INFORMATION			Symbol	Units	Nominal rod diameter (mm)							
					8	10	12	16	20	24	27	30
Minimum Embedment			$h_{ef,min}$	mm (in.)	60 (2.4)	60 (2.4)	70 (2.8)	80 (3.1)	90 (3.5)	100 (3.9)	110 (4.3)	120 (4.7)
Maximum Embedment			$h_{ef,max}$	mm (in.)	160 (6.3)	200 (7.9)	240 (9.4)	320 (12.6)	400 (15.7)	480 (18.9)	540 (21.4)	600 (23.7)
Dry concrete and water saturated concrete	Temperature range A ²	Characteristic bond strength in uncracked concrete	$\tau_{k,uncr}$	MPa (psi)	10.7 (1,550)	10.7 (1,550)	10.7 (1,550)	10.7 (1,550)	10.7 (1,550)	10.7 (1,550)	10.7 (1,550)	10.7 (1,550)
		Characteristic bond strength in uncracked concrete	$\tau_{k,uncr}$	MPa (psi)	7.4 (1,070)	7.4 (1,070)	7.4 (1,070)	7.4 (1,070)	7.4 (1,070)	7.4 (1,070)	7.4 (1,070)	7.4 (1,070)
	Anchor Category			-	2	2	2	3	3	3	3	3
	Strength Reduction factor			ϕ_c, ϕ_{ws}	-	0.55	0.55	0.55	0.45	0.45	0.45	0.45

For SI: 1 inch ≅ 25.4 mm, 1 lbf = 4.448 N, 1 psi = 0.006897 MPa.
 For pound-inch units: 1 mm = 0.03937 inches, 1 N = 0.2248 lbf, 1 MPa = 145.0 psi
¹Bond strength values correspond to concrete compressive strength f_c = 2,500 psi (17.2 MPa) [minimum of 24 MPa is required under ADIBC Appendix L, Section 5.1.1]. For concrete compressive strength, f_c, between 2,500 psi (17.2 MPa) and 8,000 psi (55.2 MPa), the tabulated characteristic bond strength may be increased by a factor of (f_c / 2,500)^{0.25} for uncracked concrete [For SI: (f_c / 17.2)^{0.25}]. See Section 4.1.4 of this report for bond strength determination.
²Temperature range A: Maximum short term temperature = 130°F (55°C), Maximum long term temperature = 110°F (43°C).
 Temperature range B: Maximum short term temperature = 176°F (80°C), Maximum long term temperature = 110°F (43°C).
 Short term elevated concrete temperatures are those that occur over brief intervals, e.g., as a result of diurnal cycling. Long term concrete temperatures are roughly constant over significant periods of time.

喜利得股份有限公司
 送審專用
 FOR REVIEW



TABLE 22—STEEL DESIGN INFORMATION FOR CANADIAN METRIC REINFORCING BARS¹

DESIGN INFORMATION		Symbol	Units	Nominal reinforcing bar size				
				10 M	15 M	20 M	25 M	30 M
Nominal bar diameter		<i>d</i>	mm (in.)	11.3 (0.445)	16.0 (0.630)	19.5 (0.768)	25.2 (0.992)	29.9 (1.177)
Bar effective cross-sectional area		<i>A_{se}</i>	mm ² (in. ²)	100.3 (0.155)	201.1 (0.312)	298.6 (0.463)	498.8 (0.773)	702.2 (1.088)
CSA G30	Nominal strength as governed by steel strength	<i>N_{sa}</i>	kN (lb)	54.0 (12,175)	108.5 (24,408)	161.5 (36,255)	270.0 (60,548)	380.0 (85,239)
		<i>V_{sa}</i>	kN (lb)	32.5 (7,305)	65.0 (14,645)	97.0 (21,753)	161.5 (36,329)	227.5 (51,144)
	Reduction for seismic shear	<i>α_{V,seis}</i>	-	0.70				
	Strength reduction factor for tension ²	<i>φ</i>	-	0.65				
	Strength reduction factor for shear ²	<i>φ</i>	-	0.60				

For SI: 1 inch ≅ 25.4 mm, 1 lbf = 4.448 N, 1 psi = 0.006897 MPa.

For pound-inch units: 1 mm = 0.03937 inches, 1 N = 0.2248 lbf, 1 MPa = 145.0 psi

¹Values provided for common rod material types based on specified strengths and calculated in accordance with ACI 318-14 Eq (17.4.1.2) or Eq (17.5.1.2b) or ACI 318-11 Eq. (D-2) and Eq. (D-29), as applicable. Other material specifications are admissible.

²For use with the load combinations of ACI 318-14 5.3 or ACI 318-11 9.2, as applicable, as set forth in ACI 318-14 17.3.3 or ACI 318-11 D.4.3, as applicable.

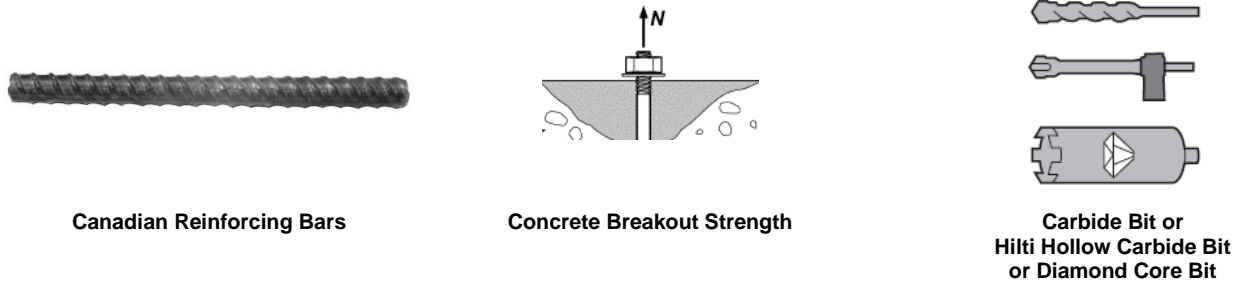

TABLE 23—CONCRETE BREAKOUT DESIGN INFORMATION FOR CANADIAN METRIC REINFORCING BARS IN HOLES DRILLED WITH A HAMMER DRILL AND CARBIDE BIT (OR HILTI HOLLOW CARBIDE DRILL BIT), OR DIAMOND CORE BIT¹

DESIGN INFORMATION		Symbol	Units	Nominal reinforcing bar size				
				10 M	15 M	20 M	25 M	30 M
Effectiveness factor for cracked concrete		<i>k_{c,cr}</i>	SI (in-lb)	7.1 (17)				
Effectiveness factor for uncracked concrete		<i>k_{c,uncr}</i>	SI (in-lb)	10 (24)				
Minimum Embedment		<i>h_{ef,min}</i>	mm (in.)	60 (2.4)	80 (3.1)	90 (3.5)	101 (4.0)	120 (4.7)
Maximum Embedment		<i>h_{ef,max}</i>	mm (in.)	226 (8.9)	320 (12.6)	390 (15.4)	504 (19.8)	598 (23.5)
Min. bar spacing ³		<i>s_{min}</i>	mm (in.)	57 (2.2)	80 (3.1)	98 (3.8)	126 (5.0)	150 (5.9)
Min. edge distance ³		<i>c_{min}</i>	mm (in.)	5 <i>d</i> ; or see Section 4.1.9 of this report for design with reduced minimum edge distances				
Minimum concrete thickness		<i>h_{min}</i>	mm (in.)	<i>h_{ef}</i> + 30 (<i>h_{ef}</i> + 1 ¹ / ₄)	<i>h_{ef}</i> + 2 <i>d_o</i> ⁽⁴⁾			
Critical edge distance – splitting (for uncracked concrete)		<i>c_{ac}</i>	-	See Section 4.1.10 of this report.				
Strength reduction factor for tension, concrete failure modes, Condition B ²		<i>φ</i>	-	0.65				
Strength reduction factor for shear, concrete failure modes, Condition B ²		<i>φ</i>	-	0.70				

For SI: 1 inch ≅ 25.4 mm, 1 lbf = 4.448 N, 1 psi = 0.006897 MPa.

For pound-inch units: 1 mm = 0.03937 inches, 1 N = 0.2248 lbf, 1 MPa = 145.0 psi

¹Additional setting information is described in Figure 9, Manufacturers Printed Installation Instructions (MPII).

²Values provided for post-installed anchors installed under Condition B without supplementary reinforcement.

³For installations with 1³/₄-inch edge distance, refer to Section 4.1.9 for spacing and maximum torque requirements.

⁴ *d_o* = hole diameter.

喜利得股份有限公司

送審專用

FOR REVIEW



Canadian Reinforcing Bars

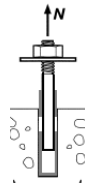

Bond Strength

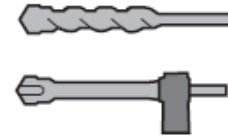

Carbide Bit or Hilti Hollow Carbide Bit

TABLE 24—BOND STRENGTH DESIGN INFORMATION FOR CANADIAN METRIC REINFORCING BARS IN HOLES DRILLED WITH A HAMMER DRILL AND CARBIDE BIT (OR HILTI HOLLOW CARBIDE DRILL BIT) ¹

DESIGN INFORMATION			Symbol	Units	Nominal reinforcing bar size				
					10M	15M	20M	25M	30M
Minimum Embedment			$h_{ef,min}$	mm (in.)	60 (2.4)	80 (3.1)	90 (3.5)	101 (4.0)	120 (4.7)
Maximum Embedment			$h_{ef,max}$	mm (in.)	226 (8.9)	320 (12.6)	390 (15.4)	504 (19.8)	598 (23.5)
Dry concrete and Water Saturated Concrete	Temperature range A ²	Characteristic bond strength in cracked concrete	$\tau_{k,cr}$	MPa (psi)	9.4 (1,360)	9.6 (1,390)	9.7 (1,410)	9.8 (1,420)	9.5 (1,380)
		Characteristic bond strength in uncracked concrete	$\tau_{k,uncr}$	MPa (psi)	12.1 (1,760)	11.8 (1,720)	11.7 (1,690)	11.3 (1,650)	11.1 (1,610)
	Temperature range B ²	Characteristic bond strength in cracked concrete	$\tau_{k,cr}$	MPa (psi)	6.5 (940)	6.6 (960)	6.7 (970)	6.8 (980)	6.5 (950)
		Characteristic bond strength in uncracked concrete	$\tau_{k,uncr}$	MPa (psi)	8.4 (1,210)	8.2 (1,190)	8.0 (1,170)	7.8 (1,140)	7.7 (1,110)
	Anchor Category		-	-	1	1	1	1	1
	Strength Reduction factor		ϕ_d, ϕ_{ws}	-	0.65	0.65	0.65	0.65	0.65
Water-filled hole	Temperature range A ²	Characteristic bond strength in cracked concrete	$\tau_{k,cr}$	MPa (psi)	6.9 (1,010)	7.2 (1,040)	7.3 (1,060)	7.4 (1,080)	7.3 (1,060)
		Characteristic bond strength in uncracked concrete	$\tau_{k,uncr}$	MPa (psi)	8.9 (1,300)	8.9 (1,280)	8.8 (1,270)	8.6 (1,250)	8.5 (1,240)
	Temperature range B ²	Characteristic bond strength in cracked concrete	$\tau_{k,cr}$	MPa (psi)	4.8 (700)	5.0 (720)	5.0 (730)	5.1 (740)	5.0 (730)
		Characteristic bond strength in uncracked concrete	$\tau_{k,uncr}$	MPa (psi)	6.2 (900)	6.1 (890)	6.1 (880)	6.0 (860)	5.9 (850)
	Anchor Category		-	-	3	3	3	3	3
	Strength Reduction factor		ϕ_{wf}	-	0.45	0.45	0.45	0.45	0.45
Submerged concrete	Temperature range A ²	Characteristic bond strength in cracked concrete	$\tau_{k,cr}$	MPa (psi)	6.1 (880)	6.3 (920)	6.5 (940)	6.8 (980)	6.6 (960)
		Characteristic bond strength in uncracked concrete	$\tau_{k,uncr}$	MPa (psi)	7.8 (1,130)	7.8 (1,140)	7.8 (1,140)	7.8 (1,140)	7.8 (1,130)
	Temperature range B ²	Characteristic bond strength in cracked concrete	$\tau_{k,cr}$	MPa (psi)	4.2 (610)	4.4 (630)	4.5 (650)	4.7 (680)	4.6 (660)
		Characteristic bond strength in uncracked concrete	$\tau_{k,uncr}$	MPa (psi)	5.4 (780)	5.4 (790)	5.4 (780)	5.4 (780)	5.4 (780)
	Anchor Category		-	-	3	3	3	3	3
	Strength Reduction factor		ϕ_{sw}	-	0.45	0.45	0.45	0.45	0.45
Reduction for seismic tension			αN_{seis}	-	0.9	0.9	0.9	0.9	0.9

For SI: 1 inch ≅ 25.4 mm, 1 lbf = 4.448 N, 1 psi = 0.006897 MPa.
For pound-inch units: 1 mm = 0.03937 inches, 1 N = 0.2248 lbf, 1 MPa = 145.0 psi

¹Bond strength values correspond to concrete compressive strength $f'_c = 2,500$ psi (17.2 MPa) [minimum of 24 MPa is required under ADIBC Appendix L, Section 5.1.1]. For concrete compressive strength, f'_c , between 2,500 psi (17.2 MPa) and 8,000 psi (55.2 MPa), the tabulated characteristic bond strength may be increased by a factor of $(f'_c / 2,500)^{0.25}$ for uncracked concrete [For SI: $(f'_c / 17.2)^{0.25}$] and $(f'_c / 2,500)^{0.15}$ for cracked concrete [For SI: $(f'_c / 17.2)^{0.15}$]. See Section 4.1.4 of this report for bond strength determination.

²Temperature range A: Maximum short term temperature = 130°F (55°C), Maximum long term temperature = 110°F (43°C).
Temperature range B: Maximum short term temperature = 176°F (80°C), Maximum long term temperature = 110°F (43°C).
Short term elevated concrete temperatures are those that occur over brief intervals, e.g., as a result of diurnal cycling. Long term concrete temperatures are roughly constant over significant periods of time.

喜利得股份有限公司
送審專用
FOR REVIEW

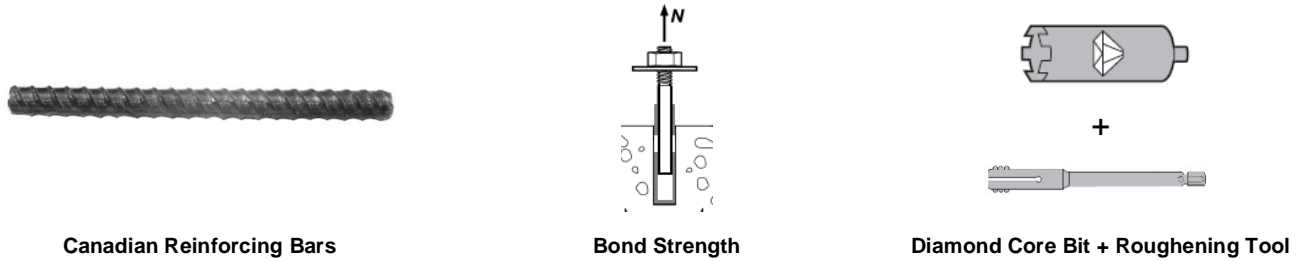

TABLE 25A—BOND STRENGTH DESIGN INFORMATION FOR CANADIAN METRIC REINFORCING BARS IN HOLES CORE DRILLED WITH A DIAMOND CORE BIT AND ROUGHENED WITH A HILTI ROUGHENING TOOL¹

DESIGN INFORMATION			Symbol	Units	Nominal reinforcing bar size		
					15M	20M	
Minimum Embedment			$h_{ef,min}$	mm (in.)	80 (3.1)	90 (3.5)	
Maximum Embedment			$h_{ef,max}$	mm (in.)	320 (12.6)	390 (15.4)	
Dry and Water Saturated concrete	Temperature range A ²	Characteristic bond strength in cracked concrete	$\tau_{k,cr}$	MPa (psi)	6.7 (970)	6.8 (985)	
		Characteristic bond strength in uncracked concrete	$\tau_{k,uncr}$	MPa (psi)	11.8 (1,720)	11.7 (1,690)	
	Temperature range B ²	Characteristic bond strength in cracked concrete	$\tau_{k,cr}$	MPa (psi)	4.6 (670)	4.7 (680)	
		Characteristic bond strength in uncracked concrete	$\tau_{k,uncr}$	MPa (psi)	8.2 (1,190)	8.0 (1,170)	
	Anchor Category			-		1	1
	Strength Reduction factor			ϕ_d, ϕ_{ws}		0.65	0.65
Reduction for seismic tension			$\Omega_{N,seis}$	-	0.9	0.9	

For SI: 1 inch \equiv 25.4 mm, 1 lbf = 4.448 N, 1 psi = 0.006897 MPa.
For pound-inch units: 1 mm = 0.03937 inches, 1 N = 0.2248 lbf, 1 MPa = 145.0 psi

¹Bond strength values correspond to concrete compressive strength in the range 2,500 psi \leq $f'_c \leq$ 8,000 psi [minimum of 24 MPa is required under ADIBC Appendix L, Section 5.1.1].

²Temperature range A: Maximum short term temperature = 130°F (55°C), Maximum long term temperature = 110°F (43°C).

Temperature range B: Maximum short term temperature = 176°F (80°C), Maximum long term temperature = 110°F (43°C).

Short term elevated concrete temperatures are those that occur over brief intervals, e.g., as a result of diurnal cycling. Long term concrete temperatures are roughly constant over significant periods of time.

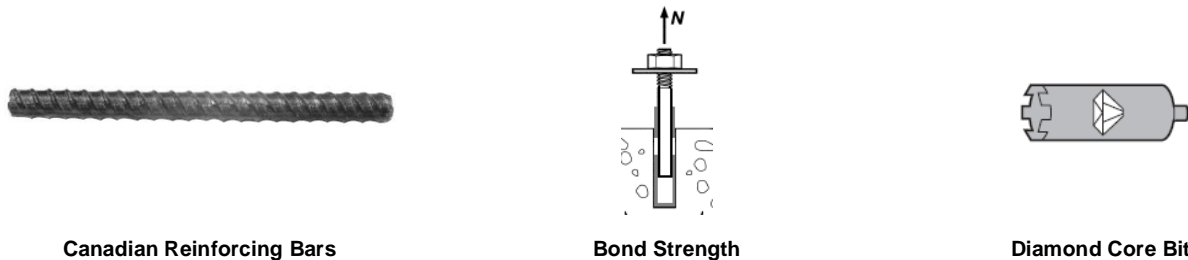

TABLE 25B—BOND STRENGTH DESIGN INFORMATION FOR CANADIAN METRIC REINFORCING BARS IN HOLES CORE DRILLED WITH A DIAMOND CORE BIT¹

DESIGN INFORMATION			Symbol	Units	Nominal reinforcing bar size				
					10M	15M	20M	25M	30M
Minimum Embedment			$h_{ef,min}$	mm (in.)	60 (2.4)	80 (3.1)	90 (3.5)	101 (4.0)	120 (4.7)
Maximum Embedment			$h_{ef,max}$	mm (in.)	226 (8.9)	320 (12.6)	390 (15.4)	504 (19.8)	598 (23.5)
Dry and Water Saturated concrete	Temperature range A ²	Characteristic bond strength in uncracked concrete	$\tau_{k,uncr}$	MPa (psi)	8.0 (1,150)	8.0 (1,150)	8.0 (1,150)	8.0 (1,150)	8.0 (1,150)
		Characteristic bond strength in uncracked concrete	$\tau_{k,uncr}$	MPa (psi)	5.5 (800)	5.5 (800)	5.5 (800)	5.5 (800)	5.5 (800)
	Anchor Category			-	2	3	3	3	3
	Strength Reduction factor			ϕ_d, ϕ_{ws}	-	0.55	0.45	0.45	0.45

For SI: 1 inch \equiv 25.4 mm, 1 lbf = 4.448 N, 1 psi = 0.006897 MPa.
For pound-inch units: 1 mm = 0.03937 inches, 1 N = 0.2248 lbf, 1 MPa = 145.0 psi

¹Bond strength values correspond to concrete compressive strength $f'_c = 2,500$ psi (17.2 MPa) [minimum of 24 MPa is required under ADIBC Appendix L, Section 5.1.1]. For concrete compressive strength, f'_c , between 2,500 psi (17.2 MPa) and 8,000 psi (55.2 MPa), the tabulated characteristic bond strength may be increased by a factor of $(f'_c / 2,500)^{0.25}$ for uncracked concrete [For SI: $(f'_c / 17.2)^{0.25}$]. See Section 4.1.4 of this report for bond strength determination.

²Temperature range A: Maximum short term temperature = 130°F (55°C), Maximum long term temperature = 110°F (43°C).

Temperature range B: Maximum short term temperature = 176°F (80°C), Maximum long term temperature = 110°F (43°C).

Short term elevated concrete temperatures are those that occur over brief intervals, e.g., as a result of diurnal cycling. Long term concrete temperatures are roughly constant over significant periods of time.

喜利得股份有限公司
送審專用
FOR REVIEW



TABLE 26—STEEL DESIGN INFORMATION FOR FRACTIONAL AND METRIC HIS-N AND HIS-RN THREADED INSERTS¹

DESIGN INFORMATION	Symbol	Units	Nominal Bolt/Cap Screw Diameter (in.) Fractional				Units	Nominal Bolt/Cap Screw Diameter (mm) Metric					
			³ / ₈	¹ / ₂	⁵ / ₈	³ / ₄		8	10	12	16	20	
			HIS Insert O.D.	<i>D</i>	in. (mm)	0.65 (16.5)		0.81 (20.5)	1.00 (25.4)	1.09 (27.6)	mm (in.)	12.5 (0.49)	16.5 (0.65)
HIS insert length	<i>l</i>	in. (mm)	4.33 (110)	4.92 (125)	6.69 (170)	8.07 (205)	mm (in.)	90 (3.54)	110 (4.33)	125 (4.92)	170 (6.69)	205 (8.07)	
Bolt effective cross-sectional area	<i>A_{se}</i>	in. ² (mm ²)	0.0775 (50)	0.1419 (92)	0.2260 (146)	0.3345 (216)	mm ² (in. ²)	36.6 (0.057)	58 (0.090)	84.3 (0.131)	157 (0.243)	245 (0.380)	
HIS insert effective cross-sectional area	<i>A_{insert}</i>	in. ² (mm ²)	0.178 (115)	0.243 (157)	0.404 (260)	0.410 (265)	mm ² (in. ²)	51.5 (0.080)	108 (0.167)	169.1 (0.262)	256.1 (0.397)	237.6 (0.368)	
ASTM A193 B7	Nominal steel strength – ASTM A193 B7 ³ bolt/cap screw	<i>N_{sa}</i> (kN)	lb (43.1)	9,690 (78.9)	17,740 (125.7)	28,250 (186.0)	41,815 (186.0)	kN (lb)	-	-	-	-	-
		<i>V_{sa}</i> (kN)	lb (25.9)	5,815 (47.3)	10,645 (75.4)	16,950 (111.6)	25,090 (111.6)	kN (lb)	-	-	-	-	-
	Nominal steel strength – HIS-N insert	<i>N_{sa}</i> (kN)	lb (56.3)	12,645 (56.3)	17,250 (76.7)	28,680 (127.6)	29,145 (129.7)	kN (lb)	-	-	-	-	-
ASTM A193 Grade B8M SS	Nominal steel strength – ASTM A193 Grade B8M SS bolt/cap screw	<i>N_{sa}</i> (kN)	lb (37.9)	8,525 (37.9)	15,610 (69.4)	24,860 (110.6)	36,795 (163.7)	kN (lb)	-	-	-	-	-
		<i>V_{sa}</i> (kN)	lb (22.8)	5,115 (22.8)	9,365 (41.7)	14,915 (66.3)	22,075 (98.2)	kN (lb)	-	-	-	-	-
	Nominal steel strength – HIS-RN insert	<i>N_{sa}</i> (kN)	lb (80.4)	18,065 (80.4)	24,645 (109.6)	40,970 (182.2)	41,635 (185.2)	kN (lb)	-	-	-	-	-
ISO 898-1 Class 8.8	Nominal steel strength – ISO 898-1 Class 8.8 bolt/cap screw	<i>N_{sa}</i> (kN)	lb (-)	-	-	-	-	kN (lb)	29.5 (6,582)	46.5 (10,431)	67.5 (15,161)	125.5 (28,236)	196.0 (44,063)
		<i>V_{sa}</i> (kN)	lb (-)	-	-	-	-	kN (lb)	17.5 (3,949)	28.0 (6,259)	40.5 (9,097)	75.5 (16,942)	117.5 (26,438)
	Nominal steel strength – HIS-N insert	<i>N_{sa}</i> (kN)	lb (-)	-	-	-	-	kN (lb)	25.0 (5,669)	53.0 (11,894)	83.0 (18,628)	125.5 (28,210)	116.5 (26,176)
ISO 3506-1 Class A4-70 Stainless	Nominal steel strength – ISO 3506-1 Class A4-70 Stainless bolt/cap screw	<i>N_{sa}</i> (kN)	lb (-)	-	-	-	-	kN (lb)	25.5 (5,760)	40.5 (9,127)	59.0 (13,266)	110.0 (24,706)	171.5 (38,555)
		<i>V_{sa}</i> (kN)	lb (-)	-	-	-	-	kN (lb)	15.5 (3,456)	24.5 (5,476)	35.5 (7,960)	66.0 (14,824)	103.0 (23,133)
	Nominal steel strength – HIS-RN insert	<i>N_{sa}</i> (kN)	lb (-)	-	-	-	-	kN (lb)	36.0 (8,099)	75.5 (16,991)	118.5 (26,612)	179.5 (40,300)	166.5 (37,394)
Reduction for seismic shear	$\alpha_{V,seis}$	-	0.94				-	0.94					
Strength reduction factor for tension ²	ϕ	-	0.65				-	0.65					
Strength reduction factor for shear ²	ϕ	-	0.60				-	0.60					

For SI: 1 inch ≅ 25.4 mm, 1 lbf = 4.448 N, 1 psi = 0.006897MPa.
For pound-inch units: 1 mm = 0.03937 inches, 1 N = 0.2248 lbf, 1 MPa = 145.0 psi

¹Values provided for common rod material types based on specified strengths and calculated in accordance with ACI 318-14 Eq. (17.4.1.2) or Eq. (17.5.1.2) of ACI 318-11 Eq. (D-2) and Eq. (D-29), as applicable. Nuts and washers must be appropriate for the rod.
²For use with the load combinations of ACI 318-14 5.3 or ACI 318-11 9.2, as applicable, as set forth in ACI 318-14 17.3.3 or ACI 318-11 D.4.3, as applicable. Values correspond to a brittle steel element for the HIS insert.
³For the calculation of the design steel strength in tension and shear for the bolt or screw, the ϕ factor for ductile steel failure according to ACI 318-14 17.3.3 or ACI 318-11 D.4.3, as applicable, can be used.

喜利得股份有限公司

送審專用

FOR REVIEW

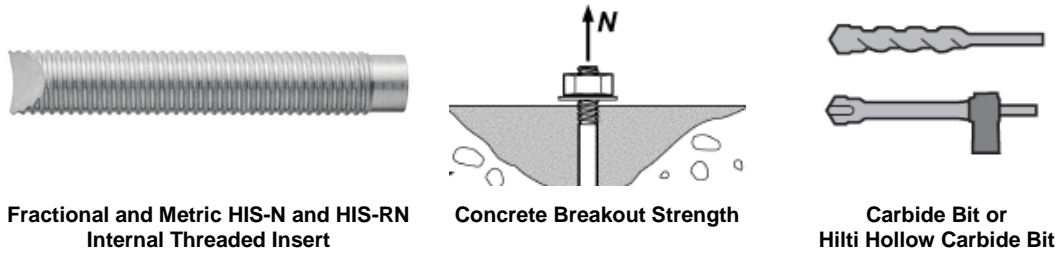

Fractional and Metric HIS-N and HIS-RN Internal Threaded Insert

Concrete Breakout Strength

Carbide Bit or Hilti Hollow Carbide Bit

TABLE 27—CONCRETE BREAKOUT DESIGN INFORMATION FOR FRACTIONAL AND METRIC HILTI HIS-N AND HIS-RN INSERTS IN HOLES DRILLED WITH A HAMMER DRILL AND CARBIDE BIT (OR HILTI HOLLOW CARBIDE DRILL BIT)¹

DESIGN INFORMATION	Symbol	Units	Nominal Bolt/Cap Screw Diameter (in.) Fractional				Units	Nominal Bolt/Cap Screw Diameter (mm) Metric				
			³ / ₈	¹ / ₂	⁵ / ₈	³ / ₄		8	10	12	16	20
Effectiveness factor for cracked concrete	$k_{c,cr}$	in-lb (SI)	17 (7.1)				SI (in-lb)	7.1 (17)				
Effectiveness factor for uncracked concrete	$k_{c,uncr}$	in-lb (SI)	24 (10)				SI (in-lb)	10 (24)				
Effective embedment depth	h_{ef}	in. (mm)	4 ³ / ₈ (110)	5 (125)	6 ³ / ₄ (170)	8 ¹ / ₈ (205)	mm (in.)	90 (3.5)	110 (4.3)	125 (4.9)	170 (6.7)	205 (8.1)
Min. anchor spacing ³	s_{min}	in. (mm)	3 ¹ / ₄ (83)	4 (102)	5 (127)	5 ¹ / ₂ (140)	mm (in.)	63 (2.5)	83 (3.25)	102 (4.0)	127 (5.0)	140 (5.5)
Min. edge distance ³	c_{min}	in. (mm)	3 ¹ / ₄ (83)	4 (102)	5 (127)	5 ¹ / ₂ (140)	mm (in.)	63 (2.5)	83 (3.25)	102 (4.0)	127 (5.0)	140 (5.5)
Minimum concrete thickness	h_{min}	in. (mm)	5.9 (150)	6.7 (170)	9.1 (230)	10.6 (270)	mm (in.)	120 (4.7)	150 (5.9)	170 (6.7)	230 (9.1)	270 (10.6)
Critical edge distance – splitting (for uncracked concrete)	c_{ac}	-	See Section 4.1.10 of this report				-	See Section 4.1.10 of this report				
Strength reduction factor for tension, concrete failure modes, Condition B ²	ϕ	-	0.65				-	0.65				
Strength reduction factor for shear, concrete failure modes, Condition B ²	ϕ	-	0.70				-	0.70				

For SI: 1 inch = 25.4 mm, 1 lbf = 4.448 N, 1 psi = 0.006897MPa.
 For pound-inch units: 1 mm = 0.03937 inches, 1 N = 0.2248 lbf, 1 MPa = 145.0 psi

¹Additional setting information is described in Figure 9A, Manufacturers Printed Installation Instructions (MPII).

²Values provided for post-installed anchors installed under Condition B without supplementary reinforcement as defined in ACI 318-14 17.3.3 or ACI 318-11 D.4.3, as applicable.

³For installations with 1³/₄-inch edge distance, refer to Section 4.1.9 for spacing and maximum torque requirements.

喜利得股份有限公司

送審專用

FOR REVIEW

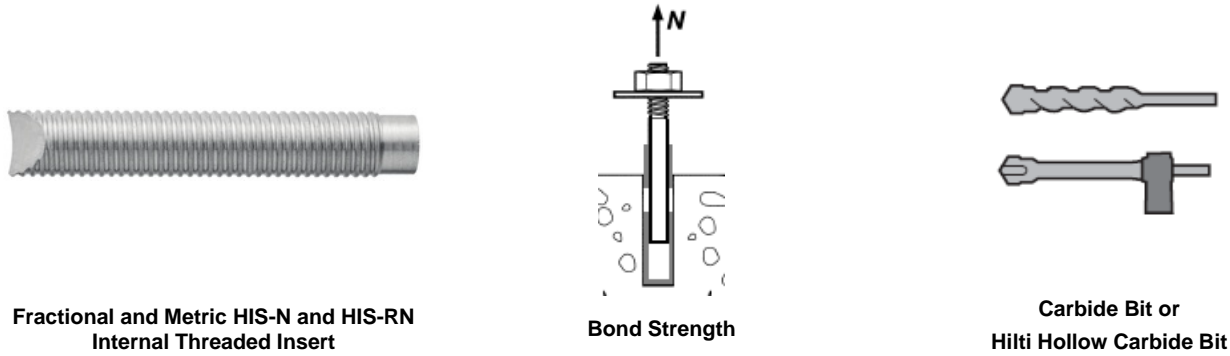

TABLE 28—BOND STRENGTH DESIGN INFORMATION FOR FRACTIONAL AND METRIC HILTI HIS-N AND HIS-RN INSERTS IN HOLES DRILLED WITH A HAMMER DRILL AND CARBIDE BIT (OR HILTI HOLLOW CARBIDE DRILL BIT)¹

DESIGN INFORMATION			Symbol	Units	Nominal bolt/cap screw diameter (in.)				Units	Nominal bolt/cap screw diameter (mm)					
					3/8	1/2	5/8	3/4		8	10	12	16	20	
Embedment			h_{ef}	in. (mm)	4 ³ / ₈ (110)	5 (125)	6 ³ / ₄ (170)	8 ¹ / ₈ (205)	mm (in.)	90 (3.5)	110 (4.3)	125 (4.9)	170 (6.7)	205 (8.1)	
Dry concrete and Water saturated concrete	Temperature range A ²	Characteristic bond strength in cracked concrete	$\tau_{k,cr}$	psi (MPa)	1,070 (7.4)	1,070 (7.4)	1,070 (7.4)	1,070 (7.4)	MPa (psi)	7.4 (1,070)	7.4 (1,070)	7.4 (1,070)	7.4 (1,070)	7.4 (1,070)	
		Characteristic bond strength in uncracked concrete	$\tau_{k,un-cr}$	psi (MPa)	1,790 (12.3)	1,790 (12.3)	1,790 (12.3)	1,790 (12.3)	MPa (psi)	12.3 (1,790)	12.3 (1,790)	12.3 (1,790)	12.3 (1,790)	12.3 (1,790)	
	Temperature range B ²	Characteristic bond strength in cracked concrete	$\tau_{k,cr}$	psi (MPa)	740 (5.1)	740 (5.1)	740 (5.1)	740 (5.1)	MPa (psi)	5.1 (740)	5.1 (740)	5.1 (740)	5.1 (740)	5.1 (740)	
		Characteristic bond strength in uncracked concrete	$\tau_{k,un-cr}$	psi (MPa)	1,240 (8.5)	1,240 (8.5)	1,240 (8.5)	1,240 (8.5)	MPa (psi)	8.5 (1,240)	8.5 (1,240)	8.5 (1,240)	8.5 (1,240)	8.5 (1,240)	
	Anchor Category			-	-	1	1	1	1	-	1	1	1	1	1
	Strength Reduction factor			ϕ_a, ϕ_{ws}	-	0.65	0.65	0.65	0.65	-	0.65	0.65	0.65	0.65	0.65
Water-filled hole	Temperature range A ²	Characteristic bond strength in cracked concrete	$\tau_{k,cr}$	psi (MPa)	800 (5.5)	810 (5.6)	820 (5.7)	820 (5.7)	MPa (psi)	5.5 (790)	5.5 (800)	5.6 (810)	5.7 (820)	5.7 (820)	
		Characteristic bond strength in uncracked concrete	$\tau_{k,un-cr}$	psi (MPa)	1,340 (9.2)	1,350 (9.3)	1,370 (9.5)	1,380 (9.5)	MPa (psi)	9.1 (1,330)	9.2 (1,340)	9.3 (1,350)	9.5 (1,370)	9.5 (1,380)	
	Temperature range B ²	Characteristic bond strength in cracked concrete	$\tau_{k,cr}$	psi (MPa)	550 (3.8)	560 (3.8)	570 (3.9)	570 (3.9)	MPa (psi)	3.8 (550)	3.8 (550)	3.8 (560)	3.9 (570)	3.9 (570)	
		Characteristic bond strength in uncracked concrete	$\tau_{k,un-cr}$	psi (MPa)	920 (6.4)	930 (6.4)	950 (6.5)	950 (6.6)	MPa (psi)	6.3 (920)	6.4 (920)	6.4 (930)	6.5 (950)	6.6 (950)	
	Anchor Category			-	-	3	3	3	3	-	3	3	3	3	3
	Strength Reduction factor			ϕ_{wf}	-	0.45	0.45	0.45	0.45	-	0.45	0.45	0.45	0.45	0.45
Submerged concrete	Temperature range A ²	Characteristic bond strength in cracked concrete	$\tau_{k,cr}$	psi (MPa)	710 (4.9)	720 (5.0)	750 (5.1)	750 (5.2)	MPa (psi)	4.8 (700)	4.9 (710)	5.0 (720)	5.1 (750)	5.2 (750)	
		Characteristic bond strength in uncracked concrete	$\tau_{k,un-cr}$	psi (MPa)	1,190 (8.2)	1,210 (8.4)	1,250 (8.6)	1,260 (8.7)	MPa (psi)	8.0 (1,160)	8.2 (1,190)	8.4 (1,210)	8.6 (1,250)	8.7 (1,260)	
	Temperature range B ²	Characteristic bond strength in cracked concrete	$\tau_{k,cr}$	psi (MPa)	490 (3.4)	500 (3.4)	510 (3.5)	520 (3.6)	MPa (psi)	3.3 (480)	3.4 (490)	3.4 (500)	3.5 (510)	3.6 (520)	
		Characteristic bond strength in uncracked concrete	$\tau_{k,un-cr}$	psi (MPa)	820 (5.6)	840 (5.8)	860 (5.9)	870 (6.0)	MPa (psi)	5.5 (800)	5.6 (820)	5.8 (840)	5.9 (860)	6.0 (870)	
	Anchor Category			-	-	3	3	3	3	-	3	3	3	3	3
	Strength Reduction factor			ϕ_{uw}	-	0.45	0.45	0.45	0.45	-	0.45	0.45	0.45	0.45	0.45
Reduction for seismic tension			$\alpha_{N,seis}$	-	1	1	1	1	-	1	1	1	1	1	

For SI: 1 inch ≅ 25.4 mm, 1 lbf = 4.448 N, 1 psi = 0.006897 MPa.
For pound-inch units: 1 mm = 0.03937 inches, 1 N = 0.2248 lbf, 1 MPa = 145.0 psi

¹Bond strength values correspond to concrete compressive strength $f_c = 2,500$ psi (17.2 MPa) [minimum of 24 MPa is required under ADIBC Appendix L, Section 5.1.1]. For concrete compressive strength, f_c , between 2,500 psi (17.2 MPa) and 8,000 psi (55.2 MPa), the tabulated characteristic bond strength may be increased by a factor of $(f_c / 2,500)^{0.25}$ for uncracked concrete [For SI: $(f_c / 17.2)^{0.25}$] and $(f_c / 2,500)^{0.15}$ for cracked concrete [For SI: $(f_c / 17.2)^{0.15}$]. See Section 4.1.4 for this report for bond strength determination.

²Temperature range A: Maximum short term temperature = 130°F (55°C), Maximum long term temperature = 110°F (43°C).
Temperature range B: Maximum short term temperature = 176°F (80°C), Maximum long term temperature = 110°F (43°C).

Short term elevated concrete temperatures are those that occur over brief intervals, e.g., as a result of diurnal cycling. Long term concrete temperatures are roughly constant over significant periods of time.

喜利得股份有限公司

送審專用

FOR REVIEW

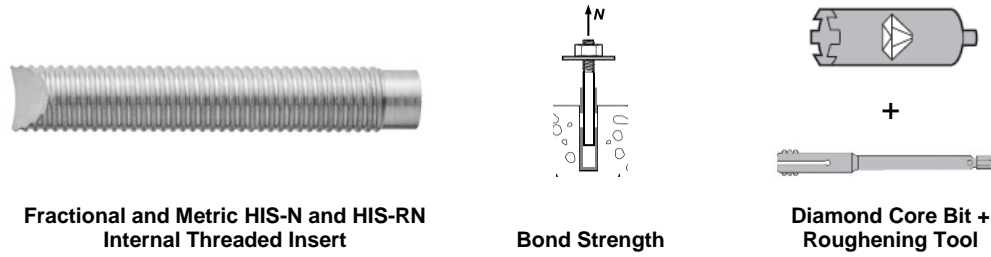

TABLE 29—BOND STRENGTH DESIGN INFORMATION FOR FRACTIONAL AND METRIC HILTI HIS-N AND HIS-RN INSERTS IN HOLES CORE DRILLED WITH A DIAMOND CORE BIT AND ROUGHENED WITH A HILTI ROUGHENING TOOL¹

DESIGN INFORMATION		Symbol	Units	Nominal bolt/cap screw diameter (in.)			Units	Nominal bolt/cap screw diameter (mm)			
				1/2	5/8	3/4		12	16	20	
Embedment		h_{ef}	in. (mm)	5 (125)	6 3/4 (170)	8 1/8 (205)	mm (in.)	125 (4.9)	170 (6.7)	205 (8.1)	
Dry concrete and Water Saturated Concrete	Temperature range A ²	Characteristic bond strength in cracked concrete	$\tau_{k,cr}$	psi (MPa)	750 (5.2)	750 (5.2)	750 (5.2)	MPa (psi)	5.2 (750)	5.2 (750)	5.2 (750)
		Characteristic bond strength in uncracked concrete	$\tau_{k,uncr}$	psi (MPa)	1,790 (12.3)	1,790 (12.3)	1,790 (12.3)	MPa (psi)	12.3 (1,790)	12.3 (1,790)	12.3 (1,790)
	Temperature range B ²	Characteristic bond strength in cracked concrete	$\tau_{k,cr}$	psi (MPa)	515 (3.6)	515 (3.6)	515 (3.6)	MPa (psi)	3.6 (515)	3.6 (515)	3.6 (515)
		Characteristic bond strength in uncracked concrete	$\tau_{k,uncr}$	psi (MPa)	1,240 (8.5)	1,240 (8.5)	1,240 (8.5)	MPa (psi)	8.5 (1,240)	8.5 (1,240)	8.5 (1,240)
	Anchor Category		-	-	1	1	1	-	1	1	1
	Strength Reduction factor		ϕ_t, ϕ_{ws}	-	0.65	0.65	0.65	-	0.65	0.65	0.65
Reduction for seismic tension		$\alpha_{N,seis}$	-	1	1	1	-	1	1	1	

For SI: 1 inch ≅ 25.4 mm, 1 lbf = 4.448 N, 1 psi = 0.006897 MPa.

For pound-inch units: 1 mm = 0.03937 inches, 1 N = 0.2248 lbf, 1 MPa = 145.0 psi

¹Bond strength values correspond to concrete compressive strength in the range 2,500 psi ≤ f_c ≤ 8,000 psi [minimum of 24 MPa is required under ADIBC Appendix L, Section 5.1.1].

²Temperature range A: Maximum short term temperature = 130°F (55°C), Maximum long term temperature = 110°F (43°C).

Temperature range B: Maximum short term temperature = 176°F (80°C), Maximum long term temperature = 110°F (43°C).

Short term elevated concrete temperatures are those that occur over brief intervals, e.g., as a result of diurnal cycling. Long term concrete temperatures are roughly constant over significant periods of time.

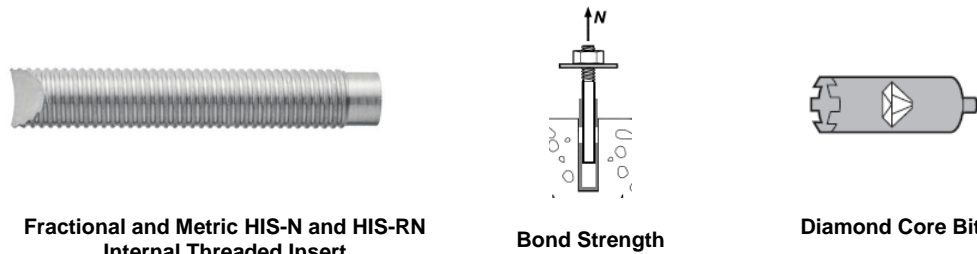

TABLE 30—BOND STRENGTH DESIGN INFORMATION FOR FRACTIONAL AND METRIC HILTI HIS-N AND HIS-RN INSERTS IN HOLES CORE DRILLED WITH A DIAMOND CORE BIT¹

DESIGN INFORMATION		Symbol	Units	Nominal bolt/cap screw diameter (in.)				Units	Nominal bolt/cap screw diameter (mm)					
				3/8	1/2	5/8	3/4		8	10	12	16	20	
Embedment		h_{ef}	in. (mm)	4 3/8 (110)	5 (125)	6 3/4 (170)	8 1/8 (205)	mm (in.)	90 (3.5)	110 (4.3)	125 (4.9)	170 (6.7)	205 (8.1)	
Dry concrete and Water Saturated Concrete	Temperature range A ²	Characteristic bond strength in uncracked concrete	$\tau_{k,uncr}$	psi (MPa)	1,200 (8.3)	1,200 (8.3)	1,200 (8.3)	1,200 (8.3)	MPa (psi)	8.3 (1,200)	8.3 (1,200)	8.3 (1,200)	8.3 (1,200)	8.3 (1,200)
		Characteristic bond strength in cracked concrete	$\tau_{k,uncr}$	psi (MPa)	830 (5.7)	830 (5.7)	830 (5.7)	830 (5.7)	MPa (psi)	5.7 (830)	5.7 (830)	5.7 (830)	5.7 (830)	5.7 (830)
	Anchor Category		-	-	3	3	3	3	-	2	3	3	3	3
	Strength Reduction factor		ϕ_t, ϕ_{ws}	-	0.45	0.45	0.45	0.45	-	0.55	0.45	0.45	0.45	0.45

For SI: 1 inch ≅ 25.4 mm, 1 lbf = 4.448 N, 1 psi = 0.006897 MPa.

For pound-inch units: 1 mm = 0.03937 inches, 1 N = 0.2248 lbf, 1 MPa = 145.0 psi

¹Bond strength values correspond to concrete compressive strength $f_c = 2,500$ psi (17.2 MPa) [minimum of 24 MPa is required under ADIBC Appendix L, Section 5.1.1]. For concrete compressive strength, f_c , between 2,500 psi (17.2 MPa) and 8,000 psi (55.2 MPa), the tabulated characteristic bond strength may be increased by a factor of $(f_c / 2,500)^{0.25}$ for uncracked concrete [For SI: $(f_c / 17.2)^{0.25}$]. See Section 4.1.4 of this report for bond strength determination.

²Temperature range A: Maximum short term temperature = 130°F (55°C), Maximum long term temperature = 110°F (43°C).

Temperature range B: Maximum short term temperature = 176°F (80°C), Maximum long term temperature = 110°F (43°C).

Short term elevated concrete temperatures are those that occur over brief intervals, e.g., as a result of diurnal cycling. Long term concrete temperatures are roughly constant over significant periods of time.

喜利得股份有限公司

送審專用

FOR REVIEW

TABLE 31—DEVELOPMENT LENGTH FOR U.S. CUSTOMARY UNIT REINFORCING BARS IN HOLES DRILLED WITH A HAMMER DRILL AND CARBIDE BIT OR HILTI HOLLOW CARBIDE BIT OR CORE DRILLED WITH A DIAMOND CORE BIT OR A DIAMOND CORE BIT AND ROUGHENED WITH A HILTI ROUGHENING TOOL ^{1,2,4,5,6}

DESIGN INFORMATION	Symbol	Criteria Section of Reference Standard	Units	Bar Size							
				#3	#4	#5	#6	#7	#8	#9	#10
Nominal reinforcing bar diameter	d_b	ASTM A615/A706	in. (mm)	0.375 (9.5)	0.500 (12.7)	0.625 (15.9)	0.750 (19.1)	0.875 (22.2)	1.000 (25.4)	1.125 (28.6)	1.250 (31.8)
Nominal bar area	A_b	ASTM A615/A706	in ² (mm ²)	0.11 (71.3)	0.20 (126.7)	0.31 (197.9)	0.44 (285.0)	0.60 (387.9)	0.79 (506.7)	1.00 (644.7)	1.27 (817.3)
Development length for $f_y = 60$ ksi and $f'_c = 2,500$ psi (normal weight concrete) ³	l_d	ACI 318 12.2.3	in. (mm)	12.0 (304.8)	14.4 (365.8)	18.0 (457.2)	21.6 (548.6)	31.5 (800.1)	36.0 (914.4)	40.5 (1028.7)	45.0 (1143.0)
Development length for $f_y = 60$ ksi and $f'_c = 4,000$ psi (normal weight concrete) ³	l_d	ACI 318 12.2.3	in. (mm)	12.0 (304.8)	12.0 (304.8)	14.2 (361.4)	17.1 (433.7)	24.9 (632.5)	28.5 (722.9)	32.0 (812.8)	35.6 (904.2)

For SI: 1 inch \equiv 25.4 mm, 1 lbf = 4.448 N, 1 psi = 0.006897 MPa.
For pound-inch units: 1 mm = 0.03937 inches, 1 N = 0.2248 lbf, 1 MPa = 145.0 psi

¹Development lengths valid for static, wind, and earthquake loads (SDC A and B).
²Development lengths in SDC C through F must comply with ACI 318-14 Chapter 18 or ACI 318-11 Chapter 21, as applicable, and section 4.2.4 of this report.
³For sand-lightweight concrete, increase development length by 33%, unless the provisions of ACI 318-14 25.4.2.4 or ACI 318-11 12.2.4 (d), as applicable, are met to permit $\lambda > 0.75$.
⁴ $\left(\frac{c_b + K_{tr}}{d_b}\right) = 2.5, \psi_t = 1.0, \psi_e = 1.0, \psi_s = 0.8$ for $d_b \leq \#6, 1.0$ for $d_b > \#6$
⁵Minimum f'_c of 24 MPa is required under ADIBC Appendix L, Section 5.1.1.
⁶Calculations may be performed for other steel grades per ACI 318-11 Chapter 12 or ACI 318-14 Chapter 25.

TABLE 32—DEVELOPMENT LENGTH FOR EU METRIC REINFORCING BARS IN HOLES DRILLED WITH A HAMMER DRILL AND CARBIDE BIT OR HILTI HOLLOW CARBIDE BIT OR CORE DRILLED WITH A DIAMOND CORE BIT OR A DIAMOND CORE BIT AND ROUGHENED WITH A HILTI ROUGHENING TOOL ^{1,2,4,5,6}

DESIGN INFORMATION	Symbol	Criteria Section of Reference Standard	Units	Bar Size					
				10	12	16	20	25	32
Nominal reinforcing bar diameter	d_b	BS4449: 2005	mm (in.)	10 (0.394)	12 (0.472)	16 (0.630)	20 (0.787)	25 (0.984)	32 (1.260)
Nominal bar area	A_b	BS 4449: 2005	mm ² (in ²)	78.5 (0.12)	113.1 (0.18)	201.1 (0.31)	314.2 (0.49)	490.9 (0.76)	804.2 (1.25)
Development length for $f_y = 72.5$ ksi and $f'_c = 2,500$ psi (normal weight concrete) ³	l_d	ACI 318 12.2.3	mm (in.)	348 (13.7)	417 (16.4)	556 (21.9)	871 (34.3)	1087 (42.8)	1392 (54.8)
Development length for $f_y = 72.5$ ksi and $f'_c = 4,000$ psi (normal weight concrete) ³	l_d	ACI 318 12.2.3	mm (in.)	305 (12.0)	330 (13.0)	439 (17.3)	688 (27.1)	859 (33.8)	1100 (43.3)

For SI: 1 inch \equiv 25.4 mm, 1 lbf = 4.448 N, 1 psi = 0.006897 MPa.
For pound-inch units: 1 mm = 0.03937 inches, 1 N = 0.2248 lbf, 1 MPa = 145.0 psi

¹Development lengths valid for static, wind, and earthquake loads (SDC A and B).
²Development lengths in SDC C through F must comply with ACI 318-14 Chapter 18 or ACI 318-11 Chapter 21 and section 4.2.4 of this report.
³For sand-lightweight concrete, increase development length by 33%, unless the provisions of ACI 318-14 25.4.2.4 or ACI 318-11 12.2.4 (d), as applicable, are met to permit $\lambda > 0.75$.
⁴ $\left(\frac{c_b + K_{tr}}{d_b}\right) = 2.5, \psi_t = 1.0, \psi_e = 1.0, \psi_s = 0.8$ for $d_b < 20$ mm, 1.0 for $d_b \geq 20$ mm
⁵Minimum f'_c of 24 MPa is required under ADIBC Appendix L, Section 5.1.1.
⁶Calculations may be performed for other steel grades per ACI 318-11 Chapter 12 or ACI 318-14 Chapter 25.

喜利得股份有限公司

送審專用

FOR REVIEW

TABLE 33—DEVELOPMENT LENGTH FOR CANADIAN REINFORCING BARS IN HOLES DRILLED WITH A HAMMER DRILL AND CARBIDE BIT OR HILTI HOLLOW CARBIDE BIT OR CORE DRILLED WITH A DIAMOND CORE BIT OR A DIAMOND CORE BIT AND ROUGHENED WITH A HILTI ROUGHENING TOOL^{1,2,4,5,6}

DESIGN INFORMATION	Symbol	Criteria Section of Reference Standard	Units	Bar Size				
				10M	15M	20M	25M	30M
Nominal reinforcing bar diameter	d_b	CAN/CSA-G30.18 Gr.400	mm (in.)	11.3 (0.445)	16.0 (0.630)	19.5 (0.768)	25.2 (0.992)	29.9 (1.177)
Nominal bar area	A_b	CAN/CSA-G30.18 Gr.400	mm ² (in ²)	100.3 (0.16)	201.1 (0.31)	298.6 (0.46)	498.8 (0.77)	702.2 (1.09)
Development length for $f_y = 58$ ksi and $f_c = 2,500$ psi (normal weight concrete) ³	l_d	ACI 318 12.2.3	mm (in.)	315 (12.4)	445 (17.5)	678 (26.7)	876 (34.5)	1,041 (41.0)
Development length for $f_y = 58$ ksi and $f_c = 4,000$ psi (normal weight concrete) ³	l_d	ACI 318 12.2.3	mm (in.)	305 (12.0)	353 (13.9)	536 (21.1)	693 (27.3)	823 (32.4)

For SI: 1 inch \equiv 25.4 mm, 1 lbf = 4.448 N, 1 psi = 0.006897 MPa.
 For pound-inch units: 1 mm = 0.03937 inches, 1 N = 0.2248 lbf, 1 MPa = 145.0 psi

¹Development lengths valid for static, wind, and earthquake loads (SDC A and B).
²Development lengths in SDC C through F must comply with ACI 318-14 Chapter 18 or ACI 318-11 Chapter 21 and section 4.2.4 of this report.
³For sand-lightweight concrete, increase development length by 33%, unless the provisions of ACI 318-14 25.4.2.4 or ACI 318-11 12.2.4 (d), as applicable, are met to permit $\lambda > 0.75$.
⁴ $\left(\frac{c_b + K_{tr}}{d_b}\right) = 2.5$, $\psi_t = 1.0$, $\psi_e = 1.0$, $\psi_s = 0.8$ for $d_b < 20M$, 1.0 for $d_b \geq 20M$
⁵Minimum f_c of 24 MPa is required under ADIBC Appendix L, Section 5.1.1.
⁶Calculations may be performed for other steel grades per ACI 318-11 Chapter 12 or ACI 318-14 Chapter 25.

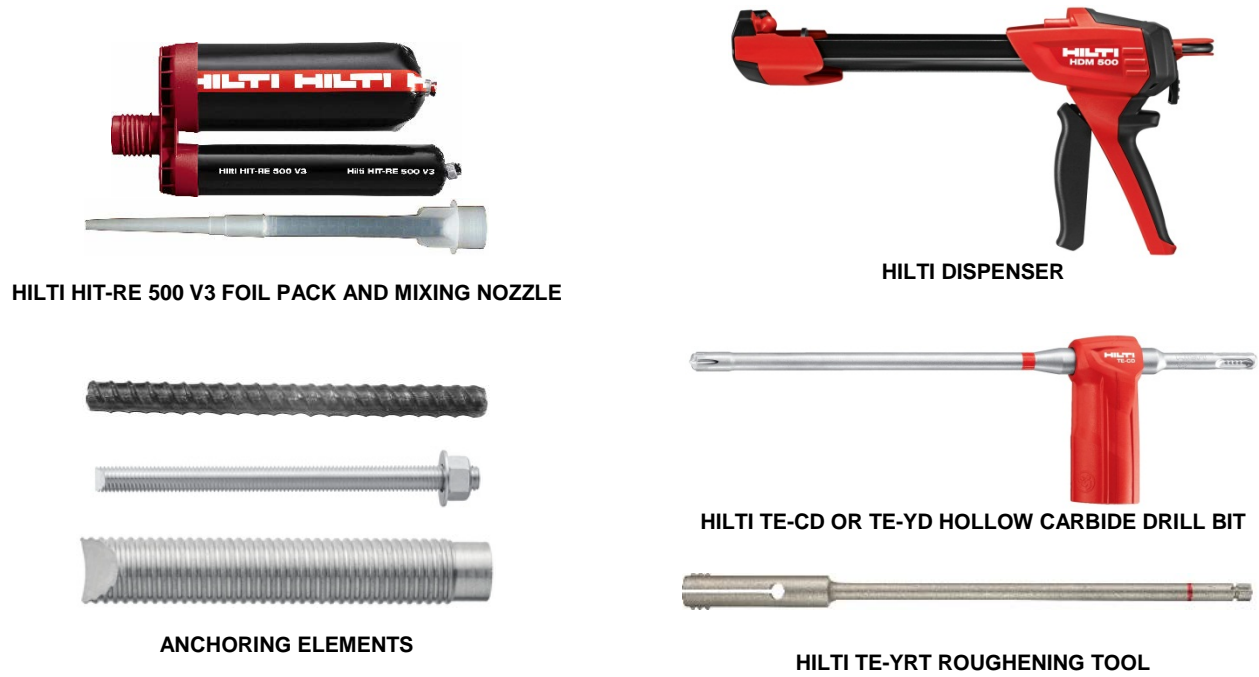

FIGURE 6—HILTI HIT-RE 500 V3 ANCHORING SYSTEM

喜利得股份有限公司
 送審專用
 FOR REVIEW

Specifications / Assumptions:

ASTM A193 Grade B7 threaded rod
 Normal weight concrete, $f'_c = 4,000$ psi
 Seismic Design Category (SDC) B
 No supplementary reinforcing in accordance with ACI 318-14 2.3 will be provided.
 Assume maximum short term (diurnal) base material temperature $\leq 130^\circ$ F.
 Assume maximum long term base material temperature $\leq 110^\circ$ F.
 Assume installation in dry concrete and hammer-drilled holes.
 Assume concrete will remain uncracked for service life of anchorage.

Dimensional Parameters:

$h_{ef} = 9.0$ in.
 $s = 4.0$ in.
 $c_{a,min} = 2.5$ in.
 $h = 12.0$ in.
 $d = 1/2$ in.

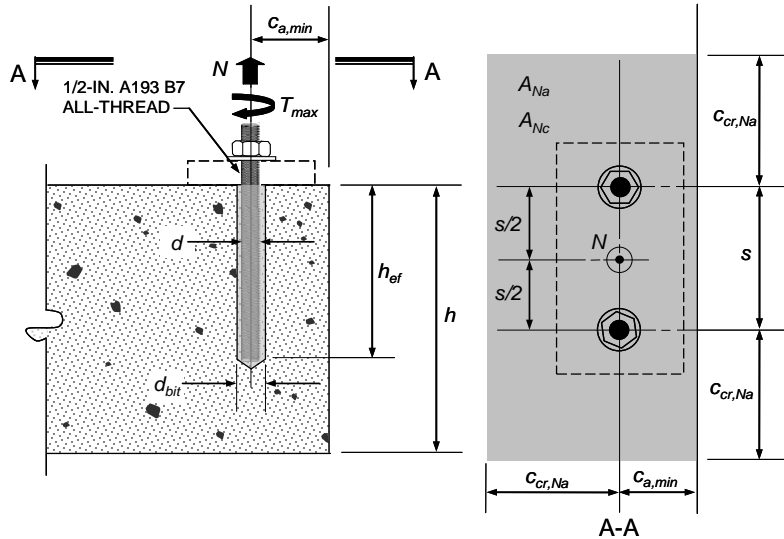

Calculation for the 2018 and 2015 IBC in accordance with ACI 318-14 Chapter 17 and this report	ACI 318-14 Code Ref.	Report Ref.
<p>Step 1. Check minimum edge distance, anchor spacing and member thickness:</p> $c_{min} = 2.5 \text{ in.} \leq c_{a,min} = 2.5 \text{ in.} \therefore \text{OK}$ $s_{min} = 2.5 \text{ in.} \leq s = 4.0 \text{ in.} \therefore \text{OK}$ $h_{min} = h_{ef} + 1.25 \text{ in.} = 9.0 + 1.25 = 10.25 \text{ in.} \leq h = 12.0 \therefore \text{OK}$ $h_{ef,min} \leq h_{ef} \leq h_{ef,max} = 2.75 \text{ in.} \leq 9 \text{ in.} \leq 10 \text{ in.} \therefore \text{OK}$	-	Table 7
<p>Step 2. Check steel strength in tension:</p> <p>Single Anchor: $N_{sa} = A_{se} \cdot f_{uta} = 0.1419 \text{ in}^2 \cdot 125,000 \text{ psi} = 17,738 \text{ lb.}$ Anchor Group: $\phi N_{sa} = \phi \cdot n \cdot A_{se} \cdot f_{uta} = 0.75 \cdot 2 \cdot 17,738 \text{ lb.} = 26,606 \text{ lb.}$ Or using Table 11: $\phi N_{sa} = 0.75 \cdot 2 \cdot 17,735 \text{ lb.} = \mathbf{26,603 \text{ lb.}}$</p>	17.4.1.2 Eq. (17.4.1.2)	Table 2 Table 6A
<p>Step 3. Check concrete breakout strength in tension:</p> $N_{cbg} = \frac{A_{Nc}}{A_{Nc0}} \cdot \psi_{ec,N} \cdot \psi_{ed,N} \cdot \psi_{c,N} \cdot \psi_{cp,N} \cdot N_b$	17.4.2.1 Eq. (17.4.2.1b)	-
$A_{Nc} = (3 \cdot h_{ef} + s)(1.5 \cdot h_{ef} + c_{a,min}) = (3 \cdot 9 + 4)(13.5 + 2.5) = \mathbf{496 \text{ in}^2}$	-	-
$A_{Nc0} = 9 \cdot h_{ef}^2 = \mathbf{729 \text{ in}^2}$	17.4.2.1 and Eq. (17.4.2.1c)	-
$\psi_{ec,N} = 1.0$ no eccentricity of tension load with respect to tension-loaded anchors	17.4.2.4	-
For $c_{a,min} < 1.5h_{ef}$ $\psi_{ed,N} = 0.7 + 0.3 \cdot \frac{c_{a,min}}{1.5h_{ef}} = 0.7 + 0.3 \cdot \frac{2.5}{1.5 \cdot 9} = \mathbf{0.76}$	17.4.2.5 and Eq. (17.4.2.5b)	-
$\psi_{c,N} = 1.0$ uncracked concrete assumed ($k_{c,uncr} = 24$)	17.4.2.6	Table 7
<p>Determine c_{ac}:</p> From Table 11: $\tau_{uncr} = 2,300$ psi $\tau_{uncr} = \frac{k_{c,uncr}}{\pi \cdot d} \sqrt{h_{ef} \cdot f'_c} = \frac{24}{\pi \cdot 0.5} \sqrt{9.0 \cdot 4,000} = 2,899 \text{ psi} > 2,300 \text{ psi} \therefore \text{use } 2,300 \text{ psi}$ $c_{ac} = h_{ef} * \left(\frac{\tau_{uncr}}{1,160}\right)^{0.4} \left[3.1 - 0.7 \frac{h}{h_{ef}}\right] = 9 * \left(\frac{2,300 \left(\frac{4,000}{2,500}\right)^{2.5}}{1,160}\right)^{0.4} \left[3.1 - 0.7 \frac{12}{9}\right] = \mathbf{26.9 \text{ in.}}$	-	Section 4.1.10 Table 11
For $c_{a,min} < c_{ac}$ $\psi_{cp,N} = \frac{\max c_{a,min}; 1.5 h_{ef} }{c_{ac}} = \frac{\max 2.5; 1.5 \cdot 9 }{26.9} = \mathbf{0.50}$	17.4.2.7 and Eq. (17.4.2.7b)	-
$N_b = k_{c,uncr} \cdot \lambda \cdot \sqrt{f'_c} \cdot h_{ef}^{1.5} = 24 \cdot 1.0 \cdot \sqrt{4,000} \cdot 9^{1.5} = \mathbf{40,983 \text{ lb.}}$	17.4.2.2 and Eq. (17.4.2.2a)	Table 7
$N_{cbg} = \frac{496}{729} * 1.0 * 0.76 * 0.50 * 40,983 = \mathbf{10,596 \text{ lb.}}$	-	Table 7
$\phi N_{cbg} = 0.65 \cdot 10,596 = \mathbf{6,887 \text{ lb.}}$	17.3.3(c)	Table 7

FIGURE 7—SAMPLE CALCULATION

喜利得股份有限公司
 送審專用
 FOR REVIEW

Step 4. Check bond strength in tension:			
$N_{ag} = \frac{A_{Na}}{A_{Na0}} \cdot \psi_{ec,Na} \cdot \psi_{ed,Na} \cdot \psi_{cp,Na} \cdot N_{ba}$		17.4.5.1 Eq. (17.4.5.1b)	-
$A_{Na} = (2C_{Na} + s)(C_{Na} + c_{a,min})$ $C_{Na} = 10d_a \sqrt{\frac{\tau_{uncr}}{1,100}} = 10 * 0.5 \sqrt{\frac{2,300 * (\frac{4,000}{2,500})^{.25}}{1,100}} = 7.67 \text{ in.}$ $A_{Na} = (2 * 7.67 + 4)(7.67 + 2.5) = 196.7 \text{ in}^2$		17.4.5.1 Eq. (17.4.5.1d)	Table 11
$A_{Na0} = (2C_{Na})^2 = (2 * 7.67)^2 = 235.3 \text{ in}^2$		17.4.5.1 and Eq. (17.4.5.1c)	-
$\psi_{ec,Na} = 1.0 \text{ no eccentricity - loading is concentric}$		17.4.5.3	-
$\psi_{ed,Na} = \left(0.7 + 0.3 \frac{c_{a,min}}{c_{na}}\right) = \left(0.7 + 0.3 \frac{2.5}{7.67}\right) = 0.80$		17.4.5.4	-
$\psi_{cp,Na} = \frac{\max\{c_{a,min}; c_{na}\}}{c_{ac}} = \frac{\max\{2.5; 7.67\}}{26.9} = 0.29$		17.4.5.5	-
$N_{ba} = \lambda \cdot \tau_{uncr} \cdot \pi \cdot d \cdot h_{ef} = 1.0 \cdot 2,300 \cdot \left(\frac{4,000}{2,500}\right)^{.25} \cdot \pi \cdot 0.5 \cdot 9.0 = 36,570 \text{ lb.}$		17.4.5.2 and Eq. (17.4.5.2)	Table 11
$N_{ag} = \frac{196.7}{235.3} * 1.0 * .80 * .29 * 36,570 = 7,092 \text{ lb.}$		-	-
$\phi N_{ag} = 0.65 * 6,256 = 4,610 \text{ lb.}$		17.3.3(c)	Table 11
Step 5. Determine controlling strength:			
Steel Strength	$\phi N_{sa} =$	26,603 lb.	17.3.1
Concrete Breakout Strength	$\phi N_{cbg} =$	6,887 lb.	
Bond Strength	$\phi N_{ag} =$	4,610 lb. CONTROLS	

FIGURE 7—SAMPLE CALCULATION (Continued)

喜利得股份有限公司
送審專用
FOR REVIEW

Specifications / Assumptions:

Development length for column starter bars

Existing construction (E):

Foundation grade beam 24 wide x 36-in deep., 4 ksi normal weight concrete, ASTM A615 Gr. 60 reinforcement

New construction (N):

18 x 18-in. column as shown, centered on 24-in wide grade beam, 4 ksi normal weight concrete, ASTM A615 Gr. 60 reinforcement, 4 - #7 column bars

The column must resist moment and shear arising from wind loading.

Dimensional Parameters:

$d_b = 0.875 \text{ in.}$

$$\left(\frac{c_b + K_{tr}}{d_b} \right) = 2.5$$

$\psi_t = 1.0$

$\psi_e = 1.0$

$\psi_s = 1.0$

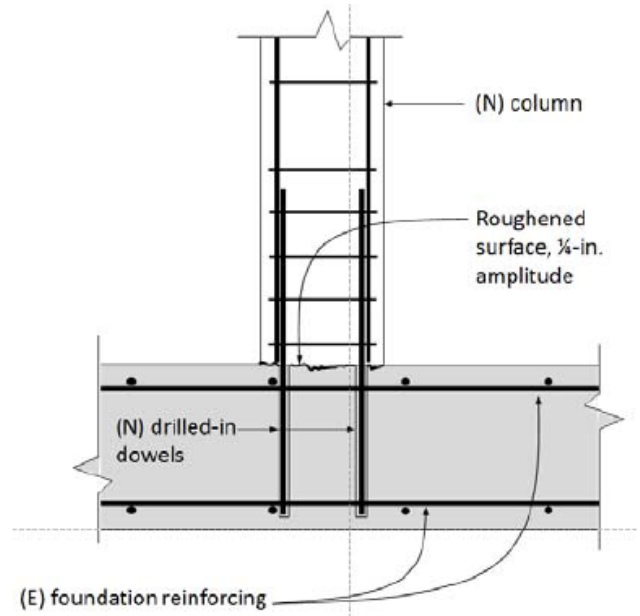

Calculation for the 2018 and 2015 IBC in accordance with ACI 318-14 Chapter 17 and this report	ACI 318-14 Code Ref.
<p>Step 1. Determination of development length for the column bars:</p> $l_d = \left[\frac{3}{40} \cdot \frac{f_y}{\lambda \cdot \sqrt{f'_c}} \cdot \frac{\psi_t \psi_e \psi_s}{c_b + K_{tr}} \right] \cdot d_b = \left[\frac{3}{40} \cdot \frac{60000}{1.0 \cdot \sqrt{4000}} \cdot \frac{(1.0)(1.0)(1.0)}{2.5} \right] \cdot 0.875 = 25 \text{ in.}$ <p>Note that the confinement term K_{tr} is taken equal to the maximum value 2.5 given the edge distance and confinement condition</p>	<p>Eq. (25.4.2.3a)</p>
<p>Step 2 Detailing (not to scale)</p>	<p>-</p>

FIGURE 8—SAMPLE CALCULATION (POST-INSTALLED REINFORCING BARS)

喜利得股份有限公司
 送審專用
 FOR REVIEW

HILTI

HilTi HIT-RE 500 V3

Instructions for use **en**
 Instrucciones de uso **es**
 Mode d'emploi **fr**
 Instruções de utilização **pt**

Danger

Contains epoxy constituents. May produce an allergic reaction (A)

Contains reaction product: bisphenol-AF-(epichlorohydrin) epoxy resin MW ≤ 700 (A), butanedioldiglycidyl ether (A), m-Xylenediamine (B), 2-methyl-1,5-pentanediamine (B)

Causes severe skin burns and eye damage (B)
 May cause respiratory irritation (B)
 May cause an allergic skin reaction (A,B)
 Toxic to aquatic life with long lasting effects (A)

ICC ES
 ICC-ES ESR - 3814

1			7/16" ... 1 3/4" 10...40 mm	2 3/8" ... 10" 60...250 mm		
2			7/16" ... 1 3/4" 10...40 mm	2 3/8" ... 7.5" 60...1920 mm		
3			7/16" ... 1 3/4" 10...40 mm	2 3/8" ... 7.5" 60...1920 mm		
4			7/16" ... 1 3/4" 10...40 mm	2 3/8" ... 10" 60...250 mm		
5			7/16" ... 1 3/4" 10...40 mm	2 3/8" ... 7.5" 60...1920 mm		
6			7/16" ... 1 3/4" 10...40 mm	2 3/8" ... 25" 60...640 mm		
7			9/16" ... 1 1/8" 14...32 mm	2 3/8" ... 10" 60...250 mm		

8			9/16" ... 1 1/8" 14...32 mm	2 3/8" ... 30 3/8" 60...1000 mm		
9			9/16" ... 1 1/8" 14...32 mm	2 3/8" ... 30 3/8" 60...1000 mm		
10			3/4" ... 1 3/8" 18...35 mm	3 1/8" ... 10" 80...250 mm		
11			3/4" ... 1 3/8" 18...35 mm	3 1/8" ... 25" 80...635 mm		
12			3/4" ... 1 3/8" 18...35 mm	3 1/8" ... 25" 80...635 mm		
13			7/16" ... 1 3/4" 10...40 mm	2 3/8" ... 10" 60...250 mm		
14			7/16" ... 1 3/4" 10...40 mm	2 3/8" ... 25" 60...640 mm		
15			7/16" ... 1 3/4" 10...40 mm	2 3/8" ... 25" 60...640 mm		

en Dry concrete Water saturated concrete Waterfilled borehole in concrete Submerged borehole in concrete

en Threaded rod Rebar Uncracked concrete Cracked concrete

en Hammer drilling Diamond coring Hollow drill bit Roughening tool

en Working time Initial curing time Curing time Roughening time

HIT-V (-R, -F, -HCR) / HAS-E (-B7) / HAS-R



HAS / HIT-V

Ø d [inch]	Ø d ₀ [inch]	h _{ref} [inch]	Ø d ₁ [inch]	T _{max} [ft-lb]	T _{max} [Nm]
3/8	7/16	2 3/8 ... 7 1/2	7/16	15	20
1/2	9/16	2 3/4 ... 10	9/16	30	41
5/8	3/4	3 1/2 ... 12 1/2	11/16	60	81
3/4	7/8	3 1/2 ... 15	13/16	100	136
7/8	1	3 1/2 ... 17 1/2	15/16	125	169
1	1 1/8	4 ... 20	1 1/8	150	203
1 1/4	1 3/8	5 ... 25	1 3/8	200	271

HIT-V

Ø d [mm]	Ø d ₀ [mm]	h _{ref} [mm]	Ø d ₁ [mm]	T _{max} [Nm]
M8	10	60...160	9	10
M10	12	60...200	12	20
M12	14	70...240	14	40
M16	18	80...320	18	80
M20	22	90...400	22	150
M24	28	100...480	26	200
M27	30	110...540	30	270
M30	35	120...600	33	300

1 inch = 25,4 mm

HIS (-N, -RN)

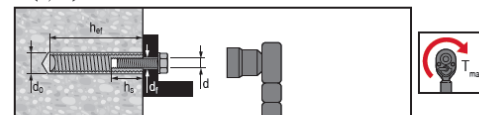

Ø d [inch]	Ø d ₀ [inch]	h _{ref} [inch]	Ø d ₁ [inch]	h ₀ [inch]	T _{max} [ft-lb]	T _{max} [Nm]
3/8	1 1/16	4 3/8	7/16	3/8 ... 1 5/16	15	20
1/2	7/8	5	9/16	1/2 ... 1 3/16	30	41
5/8	1 1/8	6 3/4	11/16	5/8 ... 1 1/2	60	81
3/4	1 1/4	8 1/8	13/16	3/4 ... 1 7/8	100	136

Ø d [mm]	Ø d ₀ [mm]	h _{ref} [mm]	Ø d ₁ [mm]	h ₀ [mm]	T _{max} [Nm]
M8	14	90	9	8...20	10
M10	18	110	12	10...25	20
M12	22	125	14	12...30	40
M16	28	170	18	16...40	80
M20	32	205	22	20...50	150

FIGURE 9A—MANUFACTURER'S PRINTED INSTALLATION INSTRUCTIONS (MPII)

喜利得股份有限公司
 送審專用
 FOR REVIEW

Rebar

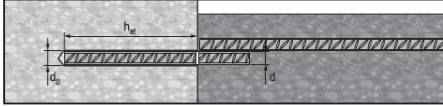

US Rebar

d	Ø d ₀ [inch]	h _{ef} [inch]
#3	1/2	2 3/8...22 1/2
#4	5/8	2 3/4...30
#5	3/4	3 1/2...37 1/2
#6	7/8	3 1/2...15
	1	15...45
#7	1	3 1/2...17 1/2
	1 1/8	17 1/2...52 1/2
#8	1 1/8	4...20
	1 1/4	20...60
#9	1 3/8	4 1/2...67 1/2
#10	1 1/2	5...75
#11	1 3/4	5 1/2...82 1/2

CA Rebar

d	Ø d ₀ [inch]	h _{ef} [mm]
10 M	9/16	70...678
15 M	3/4	80...960
20 M	1	90...1170
25 M	1 1/4 (32 mm)	101...1512
30 M	1 1/2	120...1794

1 inch = 25.4 mm

Ø	HAS	HIS-N	Rebar	HIT-RB	HIT-SZ	HIT-DL	TE-YRT
d ₀ [inch]	d [inch]			[inch]	[inch]	[inch]	[inch]
3/16	3/8	-	-	3/16	-	-	-
1/2	-	-	#3	1/2	1/2	1/2	-
5/8	1/2	-	10M	5/8	5/8	5/8	-
3/4	-	-	#4	3/4	3/4	3/4	-
11/16	-	3/8	-	11/16	11/16	11/16	-
3/4	3/4	-	15M #5	3/4	3/4	3/4	3/4
7/8	3/4	1/2	#6	7/8	7/8	7/8	7/8
1	3/4	-	20M #6 #7	1	1	1	1
1 1/8	1	5/8	#7 #8	1 1/8	1 1/8	1	1 1/8
1 1/4	-	3/4	25M #8	1 1/4	1 1/4	1	-
1 3/8	1 1/4	-	#9	1 3/8	1 3/8	1 3/8	1 3/8
1 1/2	-	-	30M #10	1 1/2	1 1/2	1 3/8	-
1 3/4	-	-	#11	1 3/4	1 3/4	1 3/8	-

HIT-DL: h_{ef} > 10"

HIT-RB: h_{ef} > 20 x d

	HIT-RE-M	HIT-OHW
Hilti VC	Art. No. 337111	Art. No. 387550

Ø	h _{ef}	Art. No. 381215	Pressure
10...32	2x4" - 52 x4"	✓	≥ 6 bar/90 psi @ 6 m/h
35...40	4" - 75"	-	≥ 140 m/h / ≥ 82 CFM

	t _{work}	t _{cur, 1d}	t _{cur, full}	
23	-5	2 h	48 h	168 h
32	0	2 h	24 h	36 h
40	4	2 h	16 h	24 h
50	10	1.5 h	12 h	16 h
60	16	1 h	8 h	16 h
72	22	25 min	4 h	6.5 h
85	29	15 min	2.5 h	5 h
95	35	12 min	2 h	4.5 h
105	41	10 min	2 h	4 h

≥ +5 °C / 41 °F

2x t_{use}

h _{ef} [inch]	h _{ef} [mm]	t _{roughen}
0 ... 4	0 ... 100	10 sec
4.01 ... 8	101 ... 200	20 sec
8.01 ... 12	201 ... 300	30 sec
12.01 ... 16	301 ... 400	40 sec
16.01 ... 20	401 ... 500	50 sec

t_{roughen} = h_{ef} [inch] * 2.5

t_{roughen} = h_{ef} [mm] / 10

Rebar

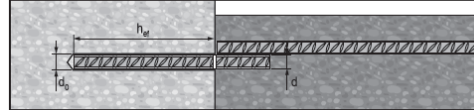

EU Rebar

Ø d [mm]	Ø d ₀ [mm]	h _{ef} [mm]
8	12	60...480
10	14	60...600
12	16	70...720
14	18	75...840
16	20	80...960
18	22	85...1080
20	25	90...1200
22	28	95...1320
24	32	96...1440
25	32	100...1500
26	35	104...1560
28	35	112...1680
30	37	120...1800
32	40	128...1920

Ø	HIT-V	HIS-N	Rebar	HIT-RB	HIT-SZ	HIT-DL	TE-YRT
d ₀ [mm]	d [mm]			[mm]	[mm]	[mm]	[mm]
10	8	-	-	10	-	-	-
12	10	-	8	12	12	12	-
14	12	8	10	14	14	14	-
16	-	-	12	16	16	16	-
18	16	10	14	18	18	18	18
20	-	-	16	20	20	20	20
22	20	12	18	22	22	20	22
25	-	-	20	25	25	25	25
28	24	16	22	28	28	25	28
30	27	-	-	30	30	25	30
32	-	20	24/25	32	32	32	32
35	30	-	28/28	35	35	32	35
37	-	-	30	37	37	32	-
40	-	-	32	40	40	32	-

HIT-DL: h_{ef} > 250 mm

HIT-RB: h_{ef} > 20 x d

	HIT-RE-M	HIT-OHW
Hilti VC	Art. No. 337111	Art. No. 387550

Ø	h _{ef}	Art. No. 381215	Pressure
10...32	60...1500	✓	≥ 6 bar/90 psi
35...40	100...1920	-	≥ 140 m/h

Rebar - h_{ef} ≥ 20d

	h _{ef}	Temperature
HDM, HDE, HIT-P 8000D	≤ US #5	12 1/2 ... 37 1/2 [inch]
	≤ EU 16mm	320 ... 960 [mm]
	≤ CAN 15M	320 ... 960 [mm]
HDE, HIT-P 8000D	≤ US #7	17 1/2 ... 52 1/8 [inch]
	≤ EU 20mm	400 ... 1200 [mm]
	≤ CAN 20M	390 ... 1170 [mm]
HIT-P 8000D	≤ US #10	25 ... 75 [inch]
	≤ EU 32mm	640 ... 1820 [mm]
	≤ CAN 30M	598 ... 1794 [mm]

	h _{ef}	Temperature
HDM, HDE, HIT-P 8000D	≤ US #5	12 1/2 ... 37 1/2 [inch]
	≤ EU 16mm	320 ... 960 [mm]
	≤ CAN 15M	320 ... 960 [mm]
HDE, HIT-P 8000D	≤ US #7	17 1/2 ... 39 3/8 [inch]
	≤ EU 20mm	400 ... 1000 [mm]
	≤ CAN 20M	390 ... 1000 [mm]

FIGURE 9A—MANUFACTURER’S PRINTED INSTALLATION INSTRUCTIONS (MPII) (Continued)

喜利得股份有限公司

送審專用

FOR REVIEW

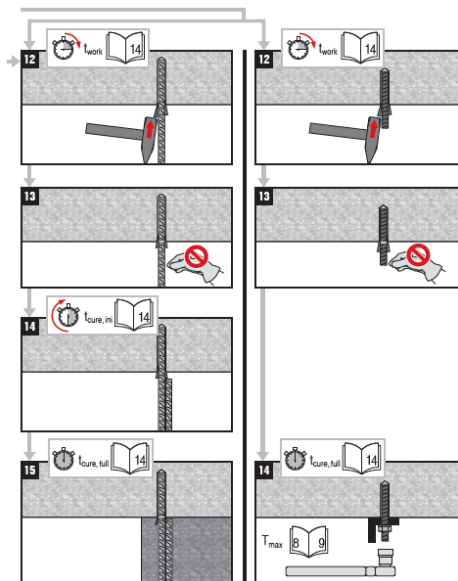
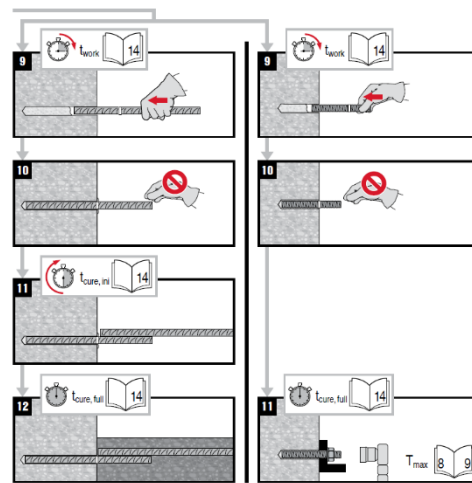
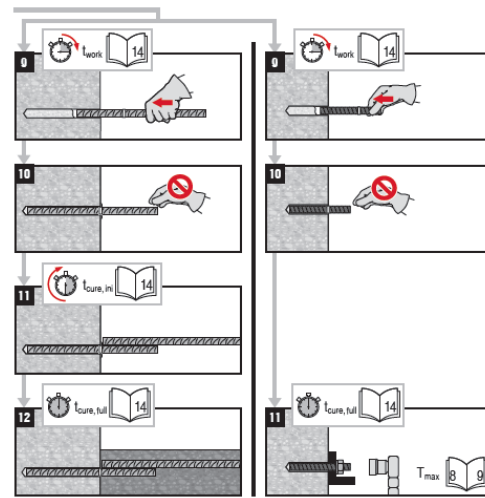
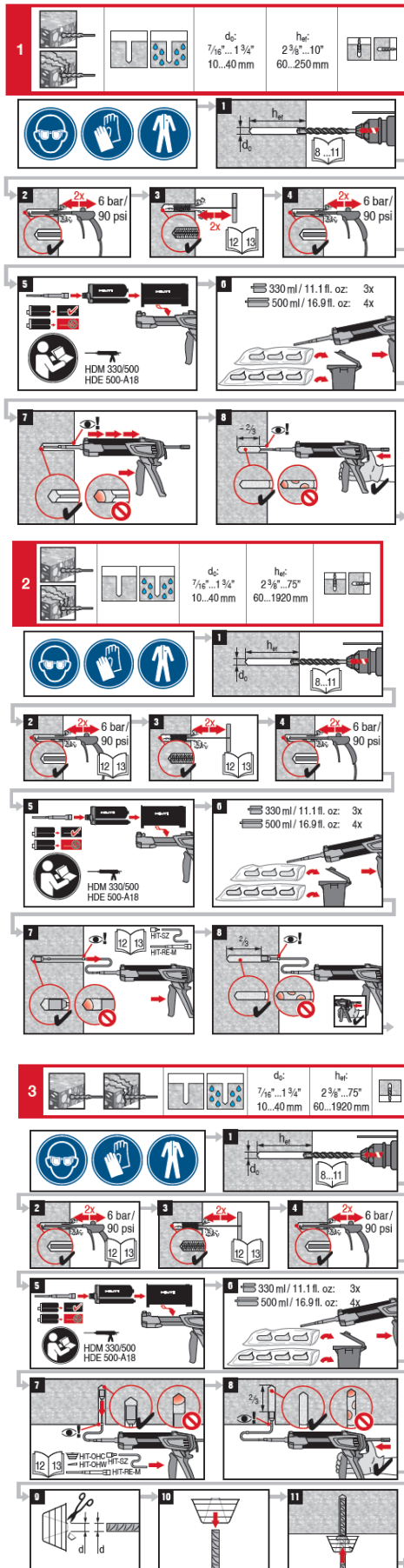

喜利得股份有限公司

送審專用

FOR REVIEW

FIGURE 9A—MANUFACTURER'S PRINTED INSTALLATION INSTRUCTIONS (MPII) (Continued)

4			$d_c:$ 7/16" ... 1 3/4" 10...40 mm	$h_{ac}:$ 2 3/8" ... 10" 60...250 mm	
	13				

1

2

3

4

5

6

7

8

9

HDM 330/500
HDE 500-A18

330 ml / 11.1 fl. oz. 3x
500 ml / 16.9 fl. oz. 4x

5			$d_c:$ 7/16" ... 1 3/4" 10...40 mm	$h_{ac}:$ 2 3/8" ... 75" 60...1920 mm	
	14				

1

2

3

4

5

6

7

8

9

HDM 330/500
HDE 500-A18

330 ml / 11.1 fl. oz. 3x
500 ml / 16.9 fl. oz. 4x

6			$d_c:$ 7/16" ... 1 3/4" 10...40 mm	$h_{ac}:$ 2 3/8" ... 25" 60...640 mm	

1

2

3

4

5

6

7

8

HDM 330/500

330 ml / 11.1 fl. oz. 3x
500 ml / 16.9 fl. oz. 4x

10

11

12

13

14

15

14

t_{work} 14

$t_{cure, in}$ 14

$t_{cure, full}$ 14

T_{max} 8 9

10

11

12

13

14

15

14

t_{work} 14

$t_{cure, in}$ 14

$t_{cure, full}$ 14

T_{max} 8 9

9

10

11

12

11

t_{work} 14

$t_{cure, in}$ 14

$t_{cure, full}$ 14

FIGURE 9A—MANUFACTURER'S PRINTED INSTALLATION INSTRUCTIONS (MPII) (Cont)

喜利得股份有限公司
送審專用
FOR REVIEW

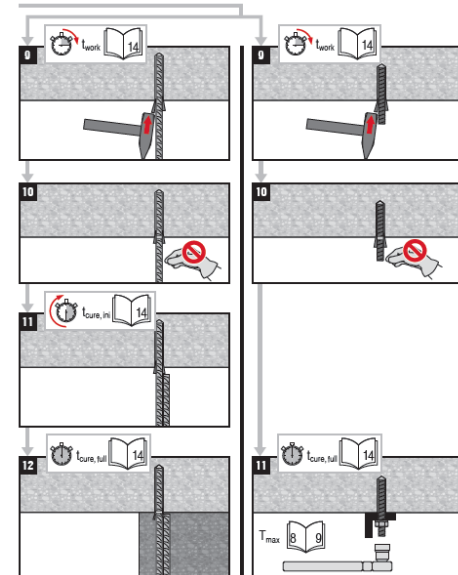
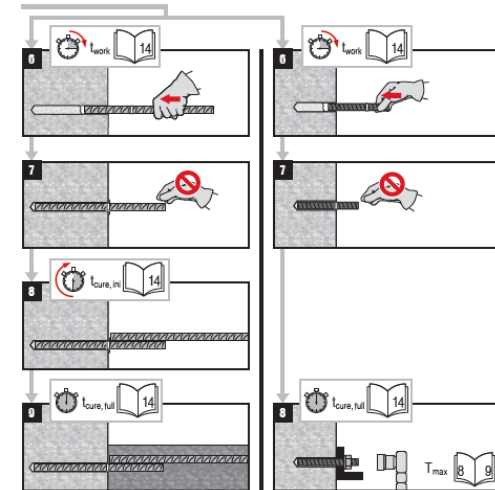
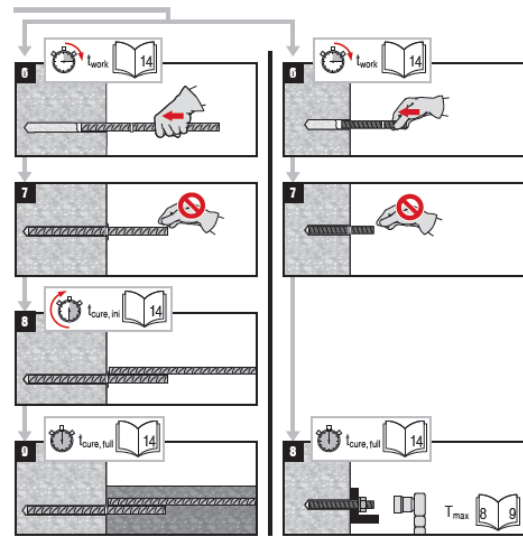
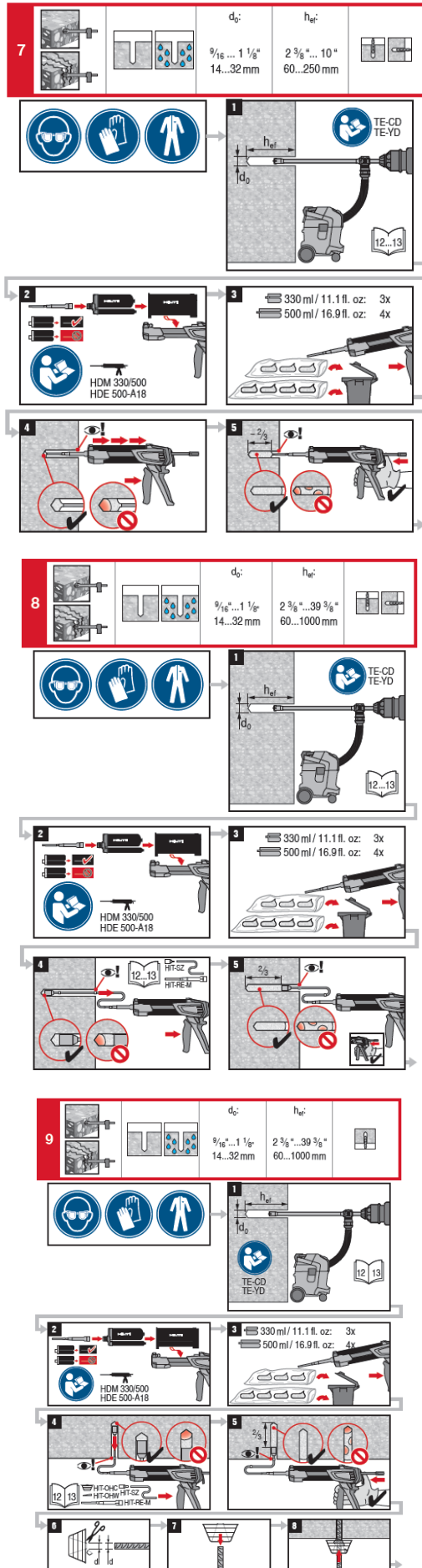

喜利得股份有限公司
 送審專用
 FOR REVIEW

FIGURE 9A—MANUFACTURER'S PRINTED INSTALLATION INSTRUCTIONS (MPII) (Cont)

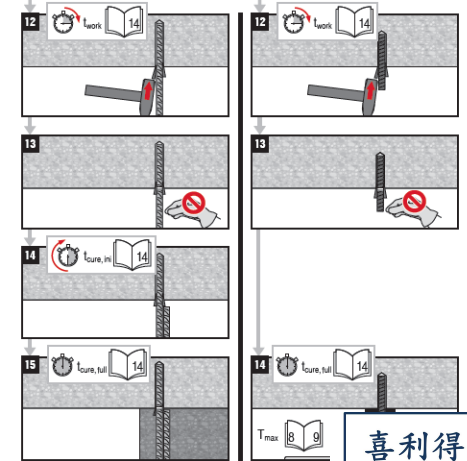
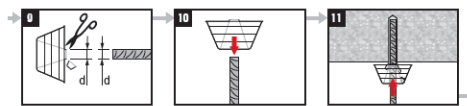
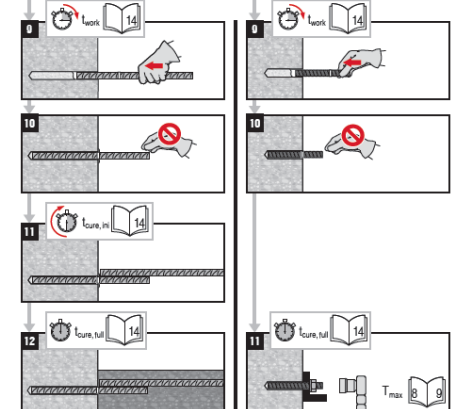
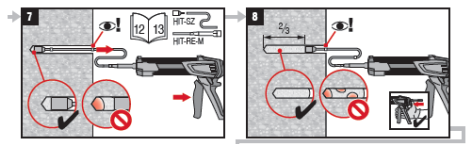
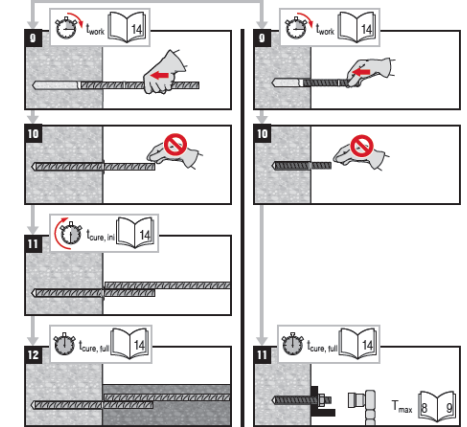
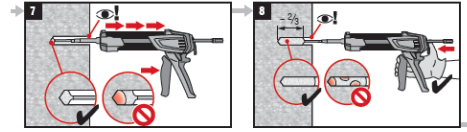
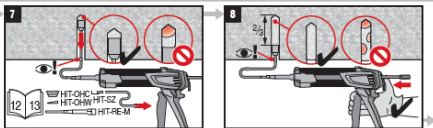
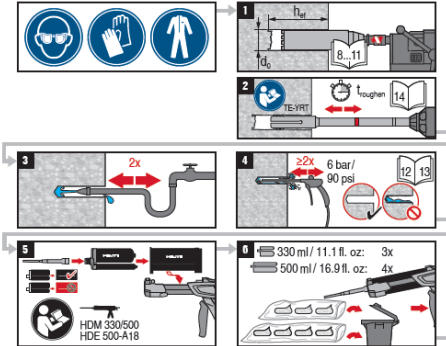
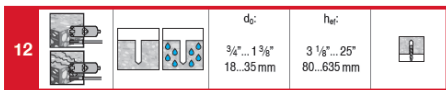
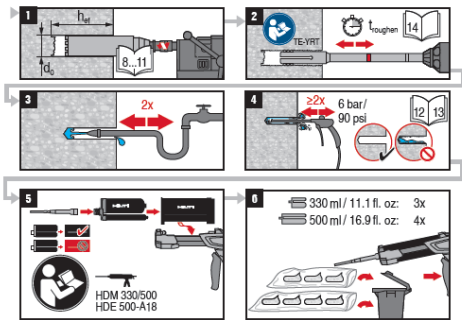
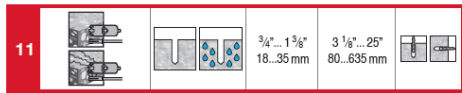
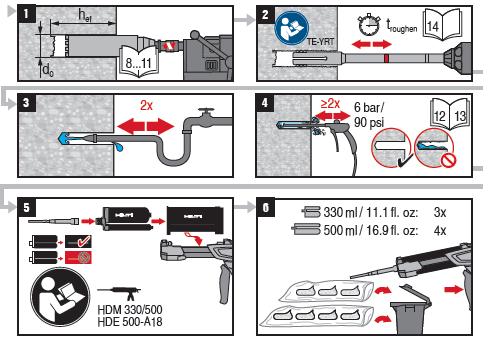
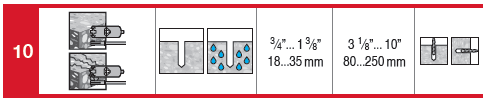

喜利得股份有限公司

送審專用

FOR REVIEW

FIGURE 9A—MANUFACTURER'S PRINTED INSTALLATION INSTRUCTIONS (MPII) (Cont)

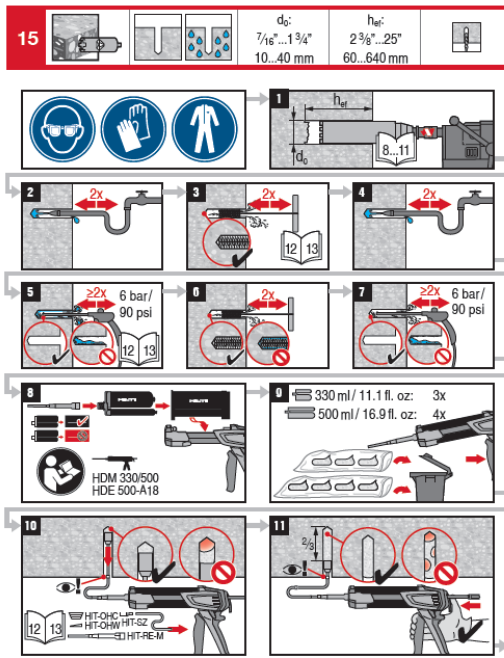

Adhesive anchoring system for rebar and anchor fastenings to concrete

- Prior to use of product, follow the instructions for use and the legally obligated safety precautions.
- See the Safety Data Sheet for this product.

HITI HIT-RE 500 V3

Contains epoxy constituents. May produce an allergic reaction. (A)

Contains: reaction product: bisphenol-A/F-(epichlorohydrin) epoxy resin MW ≤ 700 (A), butanedioldiglycidyl ether (A), m-Xylenediamine (B), 2-methyl-1,5-pentanediamine (B)

Danger

(A, B)	(A, B)	(A)
H314	Causes severe skin burns and eye damage. (A, B)	
H317	May cause an allergic skin reaction. (A, B)	
H335	May cause respiratory irritation. (B)	
H411	Toxic to aquatic life with long lasting effects. (A)	
P280	Wear protective gloves/protective clothing/eye protection/face protection.	
P290	Do not breathe vapours.	
P303+P361+P353	IF ON SKIN (or hair): Remove/Take off immediately all contaminated clothing. Rinse skin with water/shower.	
P305+P351+P338	IF IN EYES: Rinse cautiously with water for several minutes. Remove contact lenses, if present and easy to do. Continue rinsing.	
P333+P313	If skin irritation or rash occurs: Get medical advice/attention.	
P337+P313	If eye irritation persists: Get medical advice/attention.	

Recommended protective equipment:

Eye protection: Tightly sealed safety glasses e.g.: #02065449 Safety glasses PP EY-CA NCH clear; #02065591 Goggles PP EY-HA R HC/AF clear;

Protective gloves: EN 374 - Material of gloves: Nitrile rubber, NBR

Avoid direct contact with the chemical the product/the preparation by organizational measures.

Final selection of appropriate protective equipment is in the responsibility of the user

Disposal considerations

- Empty packs:**
- Leave the Mixer attached and dispose of via the local Green Dot collecting system
 - or EAK waste material code 15 01 02 plastic packaging.
- Full or partially emptied packs:**
- dispose of as special waste in accordance with official regulations.
 - EAK waste material code: 20 01 27* paint, inks, adhesives and resins containing dangerous substances.
 - or waste material code: EAK 08 04 09* waste adhesives and sealants containing organic solvents or other dangerous substances.
- Content:** 330 ml / 11.1 fl.oz. 500 ml / 16.9 fl.oz.
- Weight:** 469 g / 16.4 oz. 705 g / 24.9 oz.

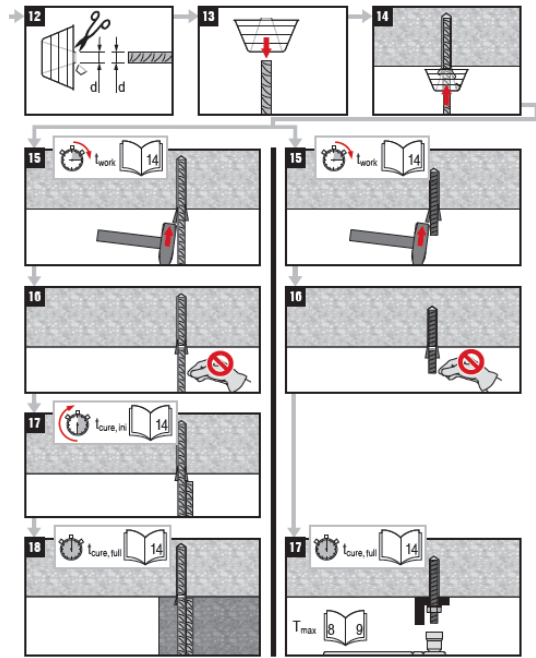

Warranty: Refer to standard Hilti terms and conditions of sale for warranty information.

Failure to observe these installation instructions, use of non-Hilti anchors, poor or questionable concrete conditions, or unique applications may affect the reliability or performance of the fastenings.

Product Information

- Always keep this instruction for use together with the product.
- Ensure that the instruction for use is with the product when it is given to other persons.
- **Safety Data Sheet:** Review the DS before use.
- **Check expiration date:** See expiration date imprint on foil pack manifold (month/year). Do not use expired product.
- **Foil pack temperature during usage:** +5 °C to 40 °C / 41 °F to 104 °F.
- **Conditions for transport and storage:** Keep in a cool, dry and dark place between +5 °C to 25 °C / 41 °F to 77 °F.
- For any application not covered by this document / beyond values specified, please contact Hilti.
- **Partly used foil packs must be used up within 4 weeks.** Leave the mixer attached on the foil pack manifold and store under the recommended storage conditions. If reused, attach a new mixer and discard the initial quantity of anchor adhesive.

WARNING

- ▲ **Improper handling may cause mortar splashes. Eye contact with mortar may cause irreversible eye damage!**
 - Always wear tightly sealed safety glasses, gloves and protective clothes before handling the mortar!
 - Never start dispensing without a mixer properly screwed on.
 - When using an extension hose: Discard of initial mortar flow must be done through supplied mixer only (not through the extension hose).
 - Attach a new mixer prior to dispensing a new foil pack (snug fit).
 - Caution! Never remove the mixer while the foil pack system is under pressure. Press the release button of the dispenser to avoid mortar splashing.
 - Use only the type of mixer supplied with the adhesive. Do not modify the mixer in any way.
 - Never use damaged foil packs and/or damaged or unclear foil pack holders.
- ▲ **Poor load values / potential failure of fastening points due to inadequate borehole cleaning. The boreholes must be dry and free of debris, dust, water, ice, oil, grease and other contaminants prior to adhesive injection.**
 - For blowing out the borehole - blow out with oil free air until return air stream is free of noticeable dust.
 - For flushing the borehole - flush with water line pressure until water runs clear.
 - Important! Remove all water from the borehole and blow out with oil free compressed air until borehole is completely dried before mortar injection (not applicable to hammer drilled hole in underwater application).
- ▲ **Ensure that boreholes are filled from the back of the boreholes without forming air voids.**
 - If necessary, use the accessories / extensions to reach the back of the borehole.
 - For overhead applications use the overhead accessories HIT-SZ / IP and take special care when inserting the fastening element. Excess adhesive may be forced out of the borehole. Make sure that no mortar drips onto the installer.
 - If a new mixer is installed onto a previously-opened foil pack, the first trigger pulls must be discarded.
 - A new mixer must be used for each new foil pack.

FIGURE 9A—MANUFACTURER’S PRINTED INSTALLATION INSTRUCTIONS (MPII) (Cont)

喜利得股份有限公司
送審專用
FOR REVIEW

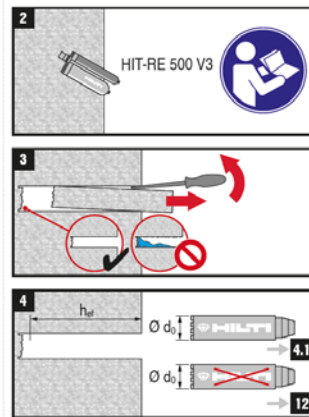
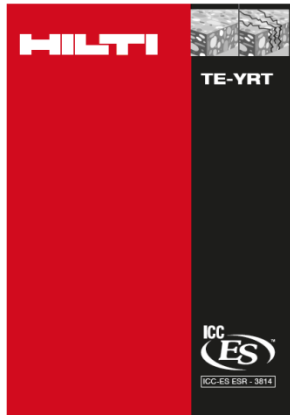

4.1	Ø d _b [mm]	TE-YRT
	18	TE-YRT 18/320
	20	TE-YRT 20/320
	22	TE-YRT 22/400
	25	TE-YRT 25/400
	28	TE-YRT 28/480
	30	TE-YRT 30/540
	32	TE-YRT 32/500
	35	TE-YRT 35/600
	Ø d _b [inch]	TE-YRT
	3/4"	TE-YRT 3/4" / 12 1/2"
	7/8"	TE-YRT 7/8" / 15"
	1"	TE-YRT 1" / 17 1/2"
	1 1/8"	TE-YRT 1 1/8" / 20"
	1 3/8"	TE-YRT 1 3/8" / 25"

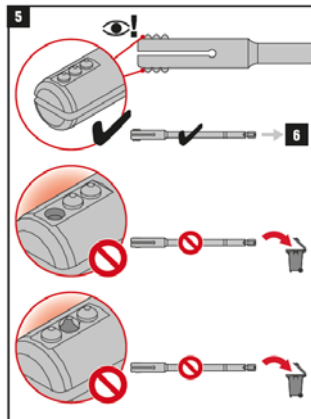

6	TE-YRT	(i) RTG
	TE-YRT 18/320	RTG 18
	TE-YRT 20/320	RTG 20
	TE-YRT 22/400	RTG 22
	TE-YRT 25/400	RTG 25
	TE-YRT 28/480	RTG 28
	TE-YRT 30/540	RTG 30
	TE-YRT 32/500	RTG 32
	TE-YRT 35/600	RTG 35
	TE-YRT	(i) RTG
	TE-YRT 3/4" / 12 1/2"	RTG 3/4"
	TE-YRT 7/8" / 15"	RTG 7/8"
	TE-YRT 1" / 17 1/2"	RTG 1"
	TE-YRT 1 1/8" / 20"	RTG 1 1/8"
	TE-YRT 1 3/8" / 25"	RTG 1 3/8"

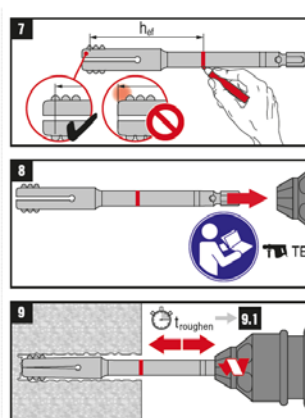
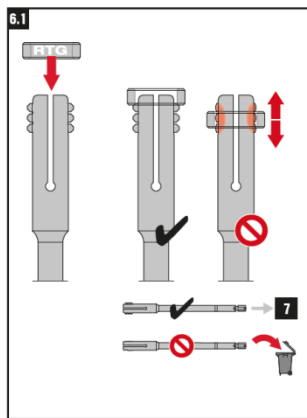

9.1	h _{dr} [mm]	t _{roughen} (= h _{dr} / 10)
	0 ... 100	10 sec
	101 ... 200	20 sec
	201 ... 300	30 sec
	301 ... 400	40 sec
	401 ... 500	50 sec
	501 ... 600	60 sec
	h _{dr} [inch]	t _{roughen} (= h _{dr} · 2.5)
	0 ... 4	10 sec
	4.01 ... 8	20 sec
	8.01 ... 12	30 sec
	12.01 ... 16	40 sec
	16.01 ... 20	50 sec
	20.01 ... 25	60 sec

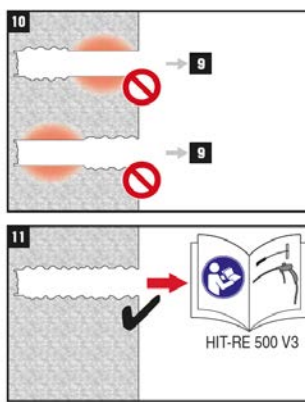
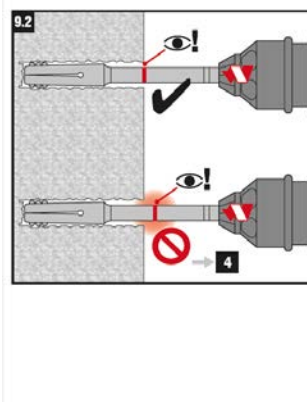

12	Ø d _b [mm]	TE-YRT
	17.9 ... 18.2	TE-YRT 18/320
	19.9 ... 20.2	TE-YRT 20/320
	21.9 ... 22.2	TE-YRT 22/400
	24.9 ... 25.2	TE-YRT 25/400
	27.9 ... 28.2	TE-YRT 28/480
	29.9 ... 30.2	TE-YRT 30/540
	31.9 ... 32.2	TE-YRT 32/500
	34.9 ... 35.2	TE-YRT 35/600
	Ø d _b [inch]	TE-YRT
	0.764 ... 0.776	TE-YRT 3/4" / 12 1/2"
	0.862 ... 0.874	TE-YRT 7/8" / 15"
	1.008 ... 1.020	TE-YRT 1" / 17 1/2"
	1.146 ... 1.157	TE-YRT 1 1/8" / 20"
	1.374 ... 1.386	TE-YRT 1 3/8" / 25"

FIGURE 9B—MANUFACTURER'S PRINTED INSTALLATION INSTRUCTIONS (MPII)

喜利得股份有限公司
送審專用
FOR REVIEW

DIVISION: 03 00 00—CONCRETE
Section: 03 16 00—Concrete Anchors

DIVISION: 05 00 00—METALS
Section: 05 05 19—Post-Installed Concrete Anchors

REPORT HOLDER:

HILTI, INC.

EVALUATION SUBJECT:

HILTI HIT-RE 500 V3 ADHESIVE ANCHORS AND POST-INSTALLED REINFORCING BAR CONNECTIONS IN CRACKED AND UNCRACKED CONCRETE

1.0 REPORT PURPOSE AND SCOPE

Purpose:

The purpose of this evaluation report supplement is to indicate that the Hilti HIT RE 500 V3 Adhesive Anchoring System and Post-Installed Reinforcing Bar System for cracked and uncracked concrete, described in ICC-ES evaluation report [ESR-3814](#), has also been evaluated for compliance with the codes noted below as adopted by the Los Angeles Department of Building and Safety (LADBS).

Applicable code editions:

- 2020 *City of Los Angeles Building Code* (LABC)
- 2020 *City of Los Angeles Residential Code* (LARC)

2.0 CONCLUSIONS

The Hilti HIT-RE 500 V3 Adhesive Anchoring System and Post-Installed Reinforcing Bar System for cracked and uncracked concrete, described in Sections 2.0 through 7.0 of the evaluation report [ESR-3814](#), complies with LABC Chapter 19, and LARC, and is subject to the conditions of use described in this supplement.

3.0 CONDITIONS OF USE

The Hilti HIT RE 500 V3 Adhesive Anchoring System and Post-Installed Reinforcing Bar System described in this evaluation report supplement must comply with all of the following conditions:

- All applicable sections in the evaluation report [ESR-3814](#).
- The design, installation, conditions of use and labeling of the Hilti HIT-RE 500 V3 Adhesive Anchoring System and Post-Installed Reinforcing Bar System are in accordance with the 2018 *International Building Code*® (2018 IBC) provisions noted in the evaluation report [ESR-3814](#).
- The design, installation and inspection are in accordance with additional requirements of LABC Chapters 16 and 17, as applicable.
- Under the LARC, an engineered design in accordance with LARC Section R301.1.3 must be submitted.
- The allowable and strength design values listed in the evaluation report and tables are for the connection of the adhesive anchors and post installed reinforcing bars to the concrete. The connection between the adhesive anchors or post installed reinforcing bars and the connected members shall be checked for capacity (which may govern).
- For use in wall anchorage assemblies to flexible diaphragm, anchors shall be designed per the requirements of City of Los Angeles Information Bulletin P/BC 2020-071.

This supplement expires concurrently with the evaluation report, reissued January 2021

DIVISION: 03 00 00—CONCRETE
Section: 03 16 00—Concrete Anchors

DIVISION: 05 00 00—METALS
Section: 05 05 19—Post-Installed Concrete Anchors

REPORT HOLDER:

HILTI, INC.

EVALUATION SUBJECT:

HILTI HIT-RE 500 V3 ADHESIVE ANCHORS AND POST-INSTALLED REINFORCING BAR CONNECTIONS IN CRACKED AND UNCRACKED CONCRETE

1.0 REPORT PURPOSE AND SCOPE

Purpose:

The purpose of this evaluation report supplement is to indicate that the Hilti HIT-RE 500 V3 Adhesive Anchors and Post-Installed Reinforcing Bar System in Concrete, described in ICC-ES evaluation report ESR-3814, has also been evaluated for compliance with the codes noted below.

Applicable code editions:

- 2017 *Florida Building Code—Building*
- 2017 *Florida Building Code—Residential*

2.0 CONCLUSIONS

The Hilti HIT-RE 500 V3 Adhesive Anchor System and Post-Installed Reinforcing Bar System, described in Sections 2.0 through 7.0 of the evaluation report ESR-3814, comply with the *Florida Building Code—Building* and the *Florida Building Code—Residential*, provided the design and installation are in accordance with the 2015 *International Building Code*® provisions noted in the evaluation report.

Use of the Hilti HIT-RE 500 V3 Adhesive Anchor System and Post-Installed Reinforcing Bar System with stainless steel threaded rod materials and reinforcing bars, and stainless steel Hilti HIS-RN inserts has also been found to be in compliance with the High-Velocity Hurricane Zone provisions of the *Florida Building Code—Building* and the *Florida Building Code—Residential*.

Use of the Hilti HIT-RE 500 V3 Adhesive Anchor System and Post-Installed Reinforcing Bar System with carbon steel threaded rod materials and reinforcing bars and carbon steel Hilti HIS-N inserts for use in dry, interior locations has also been found to be in compliance with the High-velocity Hurricane Zone provisions of the *Florida Building Code—Building* and the *Florida Building Code—Residential*.

For products falling under Florida Rule 9N-3, verification that the report holder's quality-assurance program is audited by a quality-assurance entity approved by the Florida Building Commission for the type of inspections being conducted is the responsibility of an approved validation entity (or the code official, when the report holder does not possess an approval by the Commission).

This supplement expires concurrently with the evaluation report, reissued January 2021.

附件二 HILTI HIT-RE500 V3原廠型錄

適用於鋼筋連接和重型錨固的終極性能環氧樹脂黏著劑 HIT-RE 500 V3



基礎材料

- 天然石材
- 混凝土（未開裂）
- 混凝土（開裂）

應用

- 錨定結構性鋼材 (如鋼柱、鋼樑等)
- 二級鋼結構錨定
- 用作結構連結與補強的植筋，如牆、石板、樓梯、柱、地基等的延伸／連接作業
- 翻新建築物、橋樑和其他土木結構，改造和加固混凝土結構
- 應用在鋼筋誤裝或遺漏時的補救措施
- 需要絕緣的特別應用，如緊固隧道內的緊急逃生扶手欄杆

優點

- 市面上固化最快的環氧樹脂黏著劑
- 適合用在開裂及非開裂混凝土基材上做化錨應用
- 具有抗震認證
- 高效能的表現及優越的產品科技，均得到國際認可
- 亦適合滿水孔洞與水下應用
- 慢乾型給予更大的安裝彈性



SAFESET

這是簡要說明，在不同應用可能會有所差別。請務必詳閱/遵循產品隨附的完整指示說明，或參閱您當地喜利得網站的下載區。

技術資料

材料構成	環氧樹脂 黏著劑
認證 / 測試報告	ETA, ICC-ES 報告 (混凝土), 抗震, 防火
SAFEset	是
固定類型	穿透式固定
居於能源與環保設計領導地位	是
環境狀況	室內, 乾燥條件, 室內, 濕潤環境, 水下, 淡水

指定訂購	每罐/匣容量	清孔程序	鑽石鑽頭檢測/認證	基材狀況	錨栓螺桿及組件	料號
HIT-RE 500 V3/500/1	0.5 升	壓縮空氣清潔, 自動清孔喜利得空心鑽頭	是	乾燥, 水下, 注水, 濕	HAS 螺桿, 鋼筋	2123406

喜利得注射型混合黏著劑 HIT_RE 500 V3 + 鋼筋

參考: 喜利得HIT-RE 500 V3 原廠使用手冊

1. 鑽孔

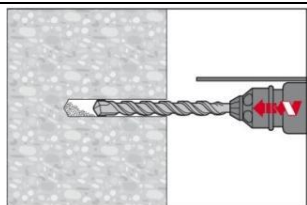

鑽孔：依照手冊標註的孔徑與深度

2. 孔洞清潔

註:未徹底清潔之孔洞會充滿沙塵, 導致施打的藥劑無法黏著而失效

A. 吹氣機清潔

適同各種孔徑與基材

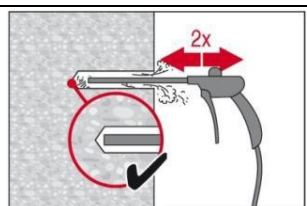

使用吹壓最小90 psi 的吹氣機, 吹氣2次

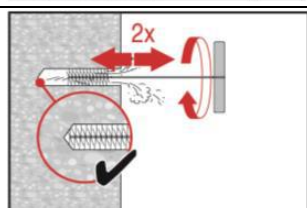

使用圓頭刷來回刷2次, 圓頭刷直徑>孔徑..

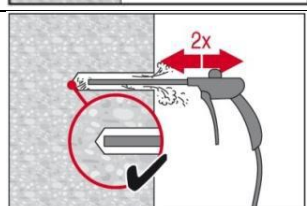

再次使用吹壓最小90 psi 的吹氣機, 吹氣2次直至沒有灰塵.

注射藥劑

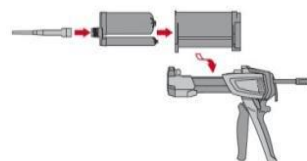

打開藥劑的保護蓋, 把藥劑放入套筒, 扭入注射嘴.
將套筒放入注射器

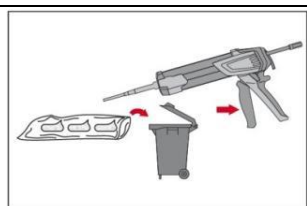

先打出並棄用首4下的未混合完全的藥劑

喜利得股份有限公司

送審專用

FOR REVIEW

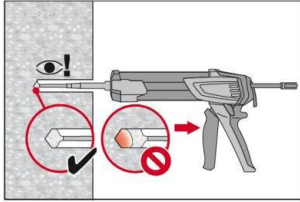

由孔洞底部植入藥劑至2/3 孔滿
 按下槍尾的按鈕以防止藥劑流出

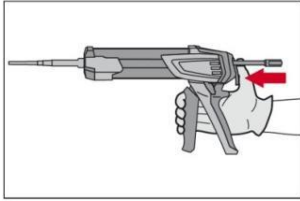

植入鋼筋(螺桿)

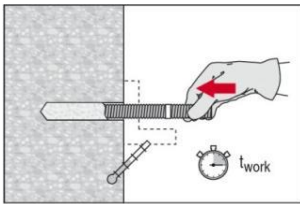

旋入鋼筋(螺桿)至底部, 表面會有少量藥劑溢出

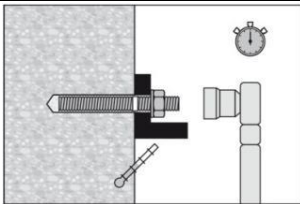

藥劑固化後, 即可緊固工作
 固化時間

	[°C]	[°F]	 t _{work}	 t _{cure, ini}	 t _{cure, full}
	5	41	2 ½ h	≥ 18 h	≥ 72 h
	10	50	2 h	≥ 12 h	≥ 48 h
	15	59	1 ½ h	≥ 8 h	≥ 24 h
	20	68	30 min	≥ 6 h	≥ 12 h
	30	86	20 min	≥ 4 h	≥ 8 h
	40	104	12 min	≥ 2 h	≥ 4 h

喜利得股份有限公司

送審專用

FOR REVIEW

附件三 材料廠商公司資料

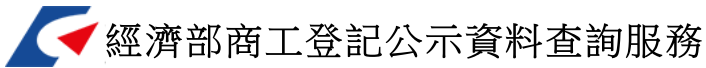

公司基本資料

統一編號	22348814
公司狀況	核准設立
股權狀況	僑外資
公司名稱	喜利得股份有限公司
章程所訂外文公司名稱	Hilti Taiwan Company Ltd.
資本總額(元)	170,000,000
實收資本額(元)	110,000,000
每股金額(元)	100
已發行股份總數(股)	1,100,000
代表人姓名	Laurent Camille Gimenez
公司所在地	新北市板橋區新站路16號24樓 電子地圖
登記機關	新北市政府
核准設立日期	075年12月31日
最後核准變更日期	109年07月17日
複數表決權特別股	無
對於特定事項具否決權特別股	無
特別股股東被選為董事、監察人之禁止或限制或當選一定名額之權利	無

所營事業資料	F106010 五金批發業
	F107170 工業助劑批發業
	F107990 其他化學製品批發業
	F113010 機械批發業
	F113020 電器批發業
	F113030 精密儀器批發業
	F113060 度量衡器批發業
	F120010 耐火材料批發業
	F206010 五金零售業
	F207170 工業助劑零售業
	F207990 其他化學製品零售業
	F213080 機械器具零售業
	F213010 電器零售業
	F213040 精密儀器零售業
	F213050 度量衡器零售業
	F220010 耐火材料零售業
	F401010 國際貿易業
	F401021 電信管制射頻器材輸入業
	E903010 防蝕、防銹工程業
	EZ99990 其他工程業
	JA02010 電器及電子產品修理業
	JE01010 租賃業
	I301010 資訊軟體服務業
	I301030 電子資訊供應服務業
	ZZ99999 除許可業務外，得經營法令非禁止或限制之業務



喜利得股份有限公司

送審專用

FOR REVIEW

新北市政府 函

機關地址：22001新北市板橋區中山路1段
161號3樓
承辦人：林梅蕙（603）
電話：(02)29603456轉5289
傳真：(02)29568030
電子郵件：AE9557@ntpc.gov.tw

105
臺北市松山區敦化北路168號15樓

受文者：喜利得股份有限公司代理人：馬靜如律師

發文日期：中華民國109年07月17日
發文字號：新北府經司字第1098050134號
速別：普通件
密等及解密條件：普通
附件：規費收據暨變更登記表1份

主旨：貴公司（統一編號：22348814）申請法人股東改派代表人為董事、補選Laurent Camille Gimenez為董事長、委任盧俊文為經理人、經理人解任變更登記，經核符合規定，准予登記。

說明：

- 一、依公司法辦理兼復貴公司109年07月15日補正（收文日）申請書。
- 二、處分相對人名稱：喜利得股份有限公司（代表人姓名：Laurent Camille Gimenez、身分證照號碼：13BC8****）、公司所在地：新北市板橋區新站路16號24樓。
- 三、檢附規費收據暨變更登記表1份，請查收。
- 四、依公司法第22條-1規定，除外商公司、公開發行股票公司及國營事業外，公司應檢視本次變更若有董事、監察人、經理人及持有已發行股份總數或資本總額超過百分之十之股東等申報資料如有變動，公司應於變動後15日內前往「公司負責人及主要股東資訊申報平臺」（網址：<https://ctp.tdcc.com.tw>）執行變動申報。未依規定完成申報或申報不實之公司，經限期通知改正仍未改正者，可處新臺幣5~500萬元罰鍰，最重將可廢止公司登記。申報方式及相關規定可前往申報平臺瀏覽或電洽412-1166。
- 五、如涉及稅籍登記部分，請於開始營業前檢送負責人身分證明文件、公司章程、許可業務之核准文件等影本洽營業所在地稽徵機關辦理；詳細文件請逕洽各地區國稅局。
- 六、對本行政處分如有不服，請依訴願法第14條及第58條規定，自行政處分書到達之次日起30日內，繕具訴願書，向本府遞送（以實際收受訴願書之日期為準，而非投郵日），並將副本抄送經濟部（地址：臺北市中正區福州街15號）。

※有關全民健康保險部分，請檢送相關表件自行向衛生福利部中央健康保險署各分區業務組，辦理有關投保單位變更事宜，相關規定請至該署全球資訊網(<https://www.nhi.gov.tw>)參閱。

※如需查詢公司登記公示資料可至本部「商工登記公示資料查詢服務」（網址為<https://findbiz.nat.gov.tw>）輸入統一編號或公司名稱即可查

喜利得股份有限公司

送審專用

FOR REVIEW

統一編號：22348814



第 1 頁 共 2 頁



詢，公示資料查得之資料與本部公司登記資料一致，敬請多加利用。

正本：喜利得股份有限公司代理人：馬靜如律師

副本：喜利得股份有限公司 負責人：Laurent Camille Gimenez (無附件)

市長侯友宜

本案依分層負責規定授權業務主管決行



裝

訂

線



喜利得股份有限公司

送審專用

FOR REVIEW



Certificate

Site certificate of main certificate Reg. no. H12455

SQS certifies herewith that the organisation mentioned below has at its disposal a management system which complies with the requirements of the normative directive listed.



Hilti Taiwan Co., Ltd.
24F., No. 16, Xinzhan Rd.,
Banqiao Dist., New Taipei City 220,
10060 Taipei Taiwan

Scope of certification

Sales

Normative base

ISO 9001:2015

Quality Management System

喜利得股份有限公司

送審專用

FOR REVIEW



Reg. no. S39941

Validity 01.07.2019–30.06.2022
Issue 01.07.2019

A. Grisard
A. Grisard, President SQS

F. Müller
F. Müller, CEO SQS



sqs.ch



Swiss Association for Quality and Management Systems (SQS)
Bernstrasse 103, 3052 Zollikofen, Switzerland



附件四 HILTI HIT-RE500 V3 TAF試驗報告

- 黏著強度 ASTM C882/C882M-13a
- 吸水率 ASTM D570-98(2010)e1
- 接著強度 CNS 1010142 (1994)
- 抗壓強度 CNS 1010142 (1994)

試驗報告

報告編號：PO-20-01007C
報告日期：2020年11月06日
頁次：第1頁；共1頁

* 工程名稱：自行測試
* 業主：NA
* 監造單位：NA
* 承包商：NA
* 供料商：喜利得股份有限公司
* 樣品名稱：HIT-RE 500 V3 化學黏著劑
* 取樣地點：NA
* 取樣人員：NA
送驗人員：喜利得股份有限公司(劉祥宇)
會驗人員：NA
* 委託單位：喜利得股份有限公司
* 聯絡資訊：NA
* 取樣日期：NA
收件日期：2020年10月08日
會驗日期：NA
試驗日期：2020年10月08日~2020年11月05日
※本報告中"*"為客戶提供之資訊

試驗結果：

序號	試驗項目	單位	試驗結果	試驗方法
1	黏著強度(2天)	kgf/cm ²	418	ASTM C882/C882M-13a
2	吸水率 (23°C, 168小時)	%	0.31	ASTM D570-98(2010) ^{e1}
3	接著強度(標準狀態)	kgf/cm ²	79.1	CNS 10142(1994)
4	抗壓強度	kgf/cm ²	975	

註：1.TAF 認可範圍為吸水率，其餘則否。

----- END -----

喜利得股份有限公司

送審專用

FOR REVIEW

本報告結果塗改無效，未經書面許可，不可部分複製，但全文複製除外。
本報告若有提供規範值時，該規範值僅供參考，且不得作為法律訴訟之憑證。
本實驗室不提供報告之符合性聲明及量測不確定度，合格之判定以委託單位實際要求為主。
本實驗室不參與抽樣，本報告結果僅對送驗樣品負責，送驗樣品批量及數量等資訊由委託單位提供。
實驗室地址：新北市新莊區幸福東路65號 電話：02-2277-3996 傳真：02-2277-3596



報告簽署人

附件五 HILTI HIT-RE500 V3防腐蝕報告

Date: 20.04.2017

Page 1 of 1

Memo

From: Hilti Taiwan Co., Ltd 喜利得股份有限公司



T 0800- 221 036
F 02-2397 3683
E

Subject: Corrosion resistance of rebar with HIT-RE 500V3

References: AC308 Table 3.8, ICC-ESR 3814

To whom it may concern:

The verification for corrosion resistance of rebar is now being covered by the AC308 ACCEPTANCE CRITERIA FOR POSTINSTALLED ADHESIVE ANCHORS IN CONCRETE ELEMENTS as per Table 3.8 (see below).

Referring to AC308 Table 3.8 and the procedures it defines in Test ref 9.4.7, we hereby confirm the corrosion resistance of rebar of Hilti HIT-RE500V3 adhesive anchoring system with the ICC-ESR No. 3814 dated January 2017, as proof.

Table 3.8– Test program for evaluating deformed reinforcing bars for use in post-installed reinforcing bar connections

Test no.	Test ref.	Testing		Bar size US/M ^{§,¶}	Assessment		f_c^*	Bar embedment ℓ_b	Minimum sample size n_{min}
		Purpose	Test parameters		α_{max}	Load & displ.			
1d	9.4.3.1	Bond resistance ^{§§}	Tension, confined, single reinforcing bar [†]	$d_{h,max}$	–	10.25.2 10.25.3	high	$7d_b$	Five
1e ^{††}	9.4.3.1	Bond resistance ^{§§}	Tension, confined, single reinforcing bar [†]	#4/12	–	10.25.2 10.25.3	high	$7d_b$	Five
2	9.4.3.2	Bond/splitting behavior	Tension, confined, reinforcing bars in corner condition	#8/25	–	10.25.6	low	$35d_b$	Six [‡]
<i>Reliability tests</i>									
3	9.4.4.1	Sensitivity to hole cleaning, dry substrate ^{***}	Tension, confined, single reinforcing bar [†]	$d_{h,max}$	≥ 0.8	10.25.7	low	$7d_b$	Five
4	9.4.4.2	Sensitivity to hole cleaning, saturated concrete ^{***}	Tension, confined, single reinforcing bar [†]	$d_{h,max}$	≥ 0.8	10.25.7	low	$7d_b$	Five
5	9.4.4.3	Sensitivity to freezing/thawing conditions ^{†††}	Tension, confined, single reinforcing bar [†]	#4/12	≥ 0.9	10.25.7	high	$7d_b$	Five
6	9.4.4.4	Sensitivity to sustained load at maximum long-term temperature ^{†††}	Tension, confined, single reinforcing bar [†]	#4/12	≥ 0.9	10.25.7	low	$7d_b$	Five
7	9.4.4.5	Decreased installation temperature ^{†††}	Tension, confined, single reinforcing bar [†]	#4/12	≥ 0.9	10.25.7	low	$7d_b$	Five
8	9.4.4.6	Sensitivity to installation direction ^{†††}	Tension, confined, single reinforcing bar [†]	$d_{h,max}$	≥ 0.9	10.25.7	low	$7d_b$	Five
<i>Installation procedure verification</i>									
9	9.4.5.1	Installation at deep embedment	Bar installation in injected hole, horizontal	$d_{h,max}$	–	10.25.8	–	$60d_b$	Three
10	9.4.5.2	Injection verification	Injection in clear tube	$d_{h,max}$	–	10.25.8	–	$60d_b$	Three
<i>Durability</i>									
11a	9.4.6.1.1	Resistance to alkalinity ^{††}	Slice test	#4/12	–	10.25.10	low	–	Ten
11b	9.4.6.1.2	Resistance to sulfur ^{††}	Slice test	#4/12	–	10.25.10	low	–	Ten
12	9.4.7	Corrosion resistance	Current and potential test	#4/12	–	10.25.9	low	$2^{1/2} \ell_r$	Three
<i>Special conditions</i>									
13	9.4.8	Seismic qualification for reinforcing bar connections ^{§§}	Cyclic tension, confined, single reinforcing bar	$d_{h,max}$	–	10.25.11	low	$7d_b$	Five
14	9.4.8	Seismic qualification for reinforcing bar connections ^{§§}	Cyclic tension, confined, single reinforcing bar	$d_{h,max}$	–	10.25.11	high	$7d_b$	Five

Excerpts of AC308 05/2016 edition page 18

PROPOSED REVISIONS TO ACCEPTANCE CRITERIA FOR POST- INSTALLED ADHESIVE ANCHORS IN CONCRETE ELEMENTS

AC308

Proposed April 2016

Compliance date June 15, 2016

Previously approved January 2016, June 2015, February 2015, September 2014, May 2014, December 2013, June 2013, February 2013, February 2012, June 2011, November 2009, June 2009, October 2008, August 2008, May 2008, February 2008, January 2008, October 2007, June 2007, February 2007, June 2006

(Previously editorially revised April 2014, October 2013, August 2013)

PREFACE

Evaluation reports issued by ICC Evaluation Service, LLC (ICC-ES), are based upon performance features of the International family of codes. (Some reports may also reference older code families such as the BOCA National Codes, the Standard Codes, and the Uniform Codes.) Section 104.11 of the *International Building Code*® reads as follows:

The provisions of this code are not intended to prevent the installation of any materials or to prohibit any design or method of construction not specifically prescribed by this code, provided that any such alternative has been approved. An alternative material, design or method of construction shall be approved where the building official finds that the proposed design is satisfactory and complies with the intent of the provisions of this code, and that the material, method or work offered is, for the purpose intended, at least the equivalent of that prescribed in this code in quality, strength, effectiveness, fire resistance, durability and safety.

ICC-ES may consider alternate criteria for report approval, provided the report applicant submits data demonstrating that the alternate criteria are at least equivalent to the criteria set forth in this document, and otherwise demonstrate compliance with the performance features of the codes. ICC-ES retains the right to refuse to issue or renew any evaluation report, if the applicable product, material, or method of construction is such that either unusual care with its installation or use must be exercised for satisfactory performance, or if malfunctioning is apt to cause injury or unreasonable damage.

NOTE: The Preface for ICC-ES acceptance criteria was revised in July 2011 to reflect changes in policy.

Acceptance criteria are developed for use solely by ICC-ES for purposes of issuing ICC-ES evaluation reports.

Copyright © 2016 ICC Evaluation Service, LLC. All rights reserved.

ANNEX 1

Annex 1 summarizes amendments to ACI 355.4. These amendments supersede applicable portions in ACI 355.4. For the purpose of satisfying this acceptance criteria, Annex 1 shall be used with ACI 355.4. The revisions herein reflect the difference in content from ACI 355.4. Sections, tables, and figures of ACI 355.4 that are modified by this Annex are presented here in their modified form. The numbering system within Annex 1 uses the number that corresponds to the location in ACI 355.4 where that change would be located. Added sections, tables, and figures are noted as such.

Keywords: anchors, concrete; cracked concrete; adhesive anchors; torque-controlled adhesive anchors, post-installed anchors

1.1 – Introduction

This criteria prescribes testing and evaluation requirements for adhesive anchors, torque-controlled adhesive anchors, and post-installed reinforcing bar systems intended for use in concrete under the provisions of ACI 318. Criteria are prescribed separately to determine the suitability of adhesive anchors and torque-controlled adhesive anchors. Included are assessments of the adhesive anchor and torque-controlled adhesive anchor systems for bond strength, reliability, service conditions, and quality control. Criteria are also provided for post-installed reinforcing bar systems as either supplemental to recognition under the criteria for adhesive anchors or as stand-alone requirements. Special inspection (13.3) is required during anchor installation as noted in 10.22. Table 1.1 provides an overview of the scope.

1.2 – Scope

This criteria applies to post-installed adhesive anchors, post-installed torque-controlled adhesive anchors, and post-installed reinforcing bars as defined herein.

Table 1.1 – Overview of anchor systems

Anchor type	Embedded part	Assessment criteria	
Adhesive anchor	Threaded rods, deformed reinforcing bars, or internally threaded steel sleeves with external deformations	Uncracked concrete	Table 3.1*
		Cracked and uncracked concrete	Table 3.2* or Table 3.3*
Torque-controlled adhesive anchor	Proprietary threaded and deformed steel element	Cracked and uncracked concrete	Table 3.6 or Table 3.7
Post-installed reinforcing bar	Deformed reinforcing bars, see Table 1.2	Cracked and uncracked concrete	Table 3.8

For multiple anchor element types, see Table 3.4. For alternate drilling methods, see Table 3.5.



Table 3.8– Test program for evaluating deformed reinforcing bars for use in post-installed reinforcing bar connections

Test no.	Test ref.	Testing Purpose	Test parameters	Bar size US/M ^{§,}	Assessment		f_c^*	Bar embedment ℓ_b	Minimum sample size n_{min}
					a_{req}	Load & displ.			
1d	9.4.3.1	Bond resistance ^{§§}	Tension, confined, single reinforcing bar [†]	$d_{b,max}$	–	10.25.2 10.25.3	high	$7d_b$	Five
1e ^{††}	9.4.3.1	Bond resistance ^{§§}	Tension, confined, single reinforcing bar [†]	#4/12	–	10.25.2 10.25.3	high	$7d_b$	Five
2	9.4.3.2	Bond/splitting behavior	Tension, confined, reinforcing bars in corner condition	#8/25	–	10.25.6	low	$35d_b$	Six [‡]
<i>Reliability tests</i>									
3	9.4.4.1	Sensitivity to hole cleaning, dry substrate ^{#,**}	Tension, confined, single reinforcing bar [†]	$d_{b,max}$	≥ 0.8	10.25.7	low	$7d_b$	Five
4	9.4.4.2	Sensitivity to hole cleaning, saturated concrete ^{#,**}	Tension, confined, single reinforcing bar [†]	$d_{b,max}$	≥ 0.8	10.25.7	low	$7d_b$	Five
5	9.4.4.3	Sensitivity to freezing/thawing conditions [#]	Tension, confined, single reinforcing bar [†]	#4/12	≥ 0.9	10.25.7	high	$7d_b$	Five
6	9.4.4.4	Sensitivity to sustained load at maximum long-term temperature [#]	Tension, confined, single reinforcing bar [†]	#4/12	≥ 0.9	10.25.7	low	$7d_b$	Five
7	9.4.4.5	Decreased installation temperature [#]	Tension, confined, single reinforcing bar [†]	#4/12	≥ 0.9	10.25.7	low	$7d_b$	Five
8	9.4.4.6	Sensitivity to installation direction [#]	Tension, confined, single reinforcing bar [†]	$d_{b,max}$	≥ 0.9	10.25.7	low	$7d_b$	Five
<i>Installation procedure verification</i>									
9	9.4.5.1	Installation at deep embedment	Bar installation in injected hole, horizontal	$d_{b,max}$	–	10.25.8	–	$60d_b$	Three
10	9.4.5.2	Injection verification	Injection in clear tube	$d_{b,max}$	–	10.25.8	–	$60d_b$	Three
<i>Durability</i>									
11a	9.4.6.1.1	Resistance to alkalinity [#]	Slice test	#4/12	–	10.25.10	low	–	Ten
11b	9.4.6.1.2	Resistance to sulfur [#]	Slice test	#4/12	–	10.25.10	low	–	Ten
12	9.4.7	Corrosion resistance	Current and potential test	#4/12	–	10.25.9	low	$2^{3/4}$ ⁿ	Three
<i>Special conditions</i>									
13	9.4.8	Seismic qualification for reinforcing bar connections ^{##}	Cyclic tension, confined, single reinforcing bar	$d_{b,max}$	–	10.25.11	low	$7d_b$	Five
14	9.4.8	Seismic qualification for reinforcing bar connections ^{§§}	Cyclic tension, confined, single reinforcing bar	$d_{b,max}$	–	10.25.11	high	$7d_b$	Five

*For definition of high- and low-strength concrete, refer to 4.3.4.

†Tests performed in test specimens in accordance with Fig. 4.5 and having minimum length/thickness of $\ell_b + 2$ in. ($\ell_b + 50$ mm).

§Sizes are U.S. customary and European metric. $d_{b,max}$ is maximum size sought for recognition.

||Perform tests with deformed reinforcing bars conforming to the mechanical requirements of 9.4.3.2.1.

#Tests are not required if corresponding test has been performed in accordance with Table 3.1, 3.2 or 3.3.

‡Test bars in three test specimens for a total of six tests with cast-in bars and six tests with post-installed bars.

**Tests shall be required if hole cleaning equipment and technique varies from that used for tests in accordance with Table 3.2 or 3.3.



附件六 ASTM E1512及E488 規範

ACCEPTANCE CRITERIA FOR POST-INSTALLED ADHESIVE ANCHORS IN CONCRETE ELEMENTS

AC308

Approved May 2014

Compliance date January 15, 2015

Previously approved December 2013, June 2013, February 2013, February 2012, June 2011, November 2009, June 2009, October 2008, August 2008, May 2008, February 2008, January 2008, October 2007, June 2007, February 2007, June 2006

(Previously editorially revised April 2014, October 2013, August 2013)

PREFACE

Evaluation reports issued by ICC Evaluation Service, LLC (ICC-ES), are based upon performance features of the International family of codes. (Some reports may also reference older code families such as the BOCA National Codes, the Standard Codes, and the Uniform Codes.) Section 104.11 of the *International Building Code*® reads as follows:

The provisions of this code are not intended to prevent the installation of any materials or to prohibit any design or method of construction not specifically prescribed by this code, provided that any such alternative has been approved. An alternative material, design or method of construction shall be approved where the building official finds that the proposed design is satisfactory and complies with the intent of the provisions of this code, and that the material, method or work offered is, for the purpose intended, at least the equivalent of that prescribed in this code in quality, strength, effectiveness, fire resistance, durability and safety.

This acceptance criteria has been issued to provide interested parties with guidelines for demonstrating compliance with performance features of the codes referenced in the criteria. The criteria was developed through a transparent process involving public hearings of the ICC-ES Evaluation Committee, and/or on-line postings where public comment was solicited.

New acceptance criteria will only have an “approved” date, which is the date the document was approved by the Evaluation Committee. When existing acceptance criteria are revised, the Evaluation Committee will decide whether the revised document should carry only an “approved” date, or an “approved” date combined with a “compliance” date. The compliance date is the date by which relevant evaluation reports must comply with the requirements of the criteria. See the ICC-ES web site for more information on compliance dates.

If this criteria is a revised edition, a solid vertical line (|) in the margin within the criteria indicates a change from the previous edition. A deletion indicator (→) is provided in the margin where any significant wording has been deleted.

ICC-ES may consider alternate criteria for report approval, provided the report applicant submits data demonstrating that the alternate criteria are at least equivalent to the criteria set forth in this document, and otherwise demonstrate compliance with the performance features of the codes. ICC-ES retains the right to refuse to issue or renew any evaluation report, if the applicable product, material, or method of construction is such that either unusual care with its installation or use must be exercised for satisfactory performance, or if malfunctioning is apt to cause injury or unreasonable damage.

NOTE: The Preface for ICC-ES acceptance criteria was revised in July 2011 to reflect changes in policy.

Acceptance criteria are developed for use solely by ICC-ES for purposes of issuing ICC-ES evaluation reports.

Copyright © 2014

喜利得股份有限公司

送審專用

FOR REVIEW

ACCEPTANCE CRITERIA FOR ADHESIVE ANCHOR SYSTEMS IN CONCRETE ELEMENTS (AC308)

1.0 INTRODUCTION

1.1 Purpose: The purpose of this acceptance criteria is to establish requirements for adhesive anchors, torque-controlled adhesive anchors, and post-installed reinforcing bars in concrete elements to be recognized in an ICC Evaluation Service, LLC (ICC-ES), evaluation report under the 2012, 2009 and 2006 *International Building Code*® (IBC), and the 2012, 2009 and 2006 *International Residential Code*® (IRC), . Bases of recognition are IBC Section 104.11 and IRC Section R104.11.

The reason for the development of this criteria is to allow for recognition of the use of adhesive anchors in concrete to create connections between structural concrete and attachments and the use of post-installed reinforcing bars in accordance with the code.

1.2 Scope: Anchors recognized under this criteria are alternatives to anchors permitted by Section 1913 of the IBC. The anchors recognized in this criteria may also be used where an engineered design is permitted in accordance with Section R301.1.2 of the IRC. Post-installed reinforcing bar systems recognized under this criteria are alternatives to cast-in-place reinforcing bars as governed by ACI 318.

1.3 Codes and Referenced Standards: Where standards are referenced in this criteria, these standards shall be applied consistently with the code upon which compliance is based. Standards editions listed in this section apply to all codes. Where standards editions are not listed in this section, Table 1 summarizes the specific date applicable to each code.

1.3.1 2012, 2009 and 2006 *International Building Code*® (IBC), International Code Council.

1.3.2 2012, 2009 and 2006 *International Residential Code*® (IRC), International Code Council.

1.3.3 ACI 318, Building Code Requirements for Structural Concrete, American Concrete Institute.

1.3.4 ACI 355.4, Acceptance Criteria for Qualification of Post-installed Adhesive Anchors in Concrete, American Concrete Institute.

1.3.5 ACI 211.1-91 (2002), Standard Practice for Selecting Proportions for Normal, Heavyweight and Mass Concrete, American Concrete Institute.

1.3.6 ANSI B 212.15-1994, American National Standard for Cutting Tools – Carbide Tipped Masonry Drills and Blanks for Carbide-Tipped Masonry Drills, American National Standards Institute.

1.3.7 ASTM A153, Standard Specification for Zinc Coating (Hot-Dip) on Iron and Steel Hardware, ASTM International.

1.3.8 ASTM A193/A 193 M-06a, Standard Specification for Alloy-Steel and Stainless Steel Bolting Materials for High Temperature or High Pressure Service and Other Special Purpose Applications, ASTM International.

1.3.9 ASTM A490-04a, Standard Specification for Heat-Treated Steel Structural Bolts, 150 ksi Minimum Tensile Strength, ASTM International.

1.3.10 ASTM B695, Standard Specification for Coatings of Zinc Mechanically Deposited on Iron and Steel, ASTM International.

1.3.11 ASTM C31, Standard Practice for Making and Curing Concrete Test Specimens in the Field, ASTM International.

1.3.12 ASTM C33-03, Standard Specification for Concrete Aggregates, ASTM International.

1.3.13 ASTM C39, Standard Test Method for Compressive Strength of Cylindrical Concrete Specimens, ASTM International.

1.3.14 ASTM C42, Standard Test Method for Obtaining and Testing Drilled Cores and Sawed Beams of Concrete, ASTM International.

1.3.15 ASTM C150, Standard Specification for Portland Cement, ASTM International.

1.3.16 ASTM C330, Standard Specification for Lightweight Aggregates for Structural Concrete, ASTM International.

1.3.17 ASTM C882-05, Standard Test Method for Bond Strength of Epoxy-Resin Systems Used with Concrete by Slant Shear, ASTM International.

1.3.18 ASTM D1875-03, Standard Test Method for Density of Adhesives in Fluid Form, ASTM International.

1.3.19 ASTM D2471-99, Standard Test Method for Gel Time and Peak Exothermic Temperature of Reacting Thermosetting Resins, ASTM International.

1.3.20 ASTM D2556-93a(2005), Standard Test Method for Apparent Viscosity of Adhesives Having Shear-Rate-Dependent Flow Properties, ASTM International.

1.3.21 ASTM E488-96(2003), Standard Test Method for Strength of Anchors in Concrete and Masonry Elements, ASTM International.

1.3.22 ASTM E1252-98(2002), Standard Practice for General Techniques for Obtaining Infrared Spectra for Qualitative Analysis, ASTM International.

1.3.23 ASTM E1512-01, Standard Test Methods for Testing Bond Performance of Adhesive-Bonded Anchors, ASTM International.

1.3.24 ASTM F606-05, Standard Test Methods for Determining the Mechanical Properties of Externally and Internally Threaded Fasteners, Washers, and Rivets, ASTM International.

1.3.25 ASTM F1080-93(2002), Standard Test Method for Determining the Consistency of Viscous Liquids Using a Consistometer, ASTM International.

1.3.26 EB001, Design and Control of Concrete Mixtures, 14th edition, 2002, Portland Cement Association.

1.4 Definitions:

1.4.1 ACI 355.4: The referenced document in Section 1.3.4 as amended by Annex 1.

1.4.2 Anchor Test Series: A group of identical anchors tested under identical conditions. The anchors originate from the same adhesive formulation.

