

# HILTI

**TE 30**  
**TE 30-AVR**  
**TE 30-C-AVR**

Deutsch	de
English	en
Français	fr
Italiano	it
Español	es
Português	pt
Nederlands	nl
Dansk	da
Svenska	sv
Norsk	no
Suomi	fi
Ελληνικά	el
عربي	ar
Latviešu	lv
Lietuvių	lt
Eesti	et

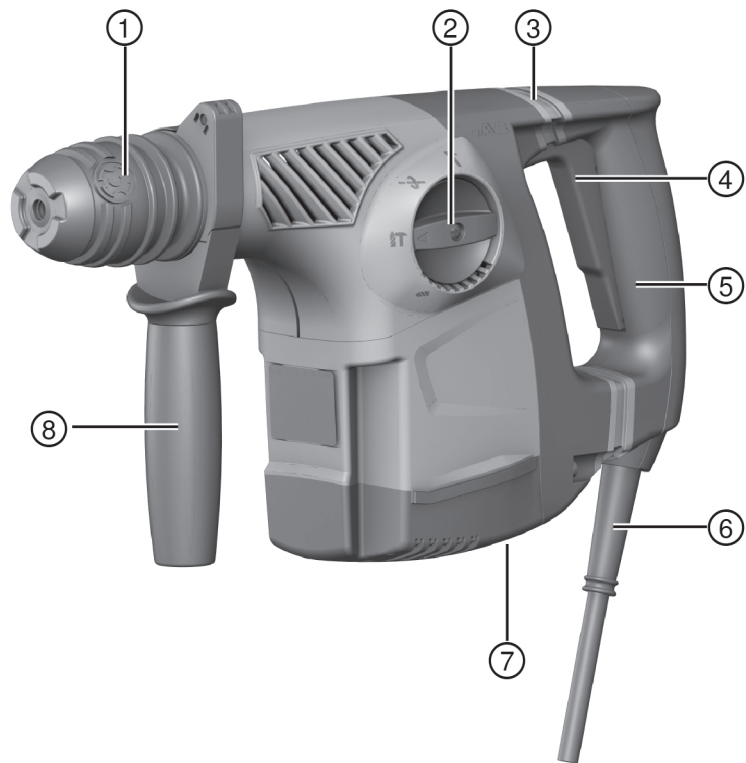



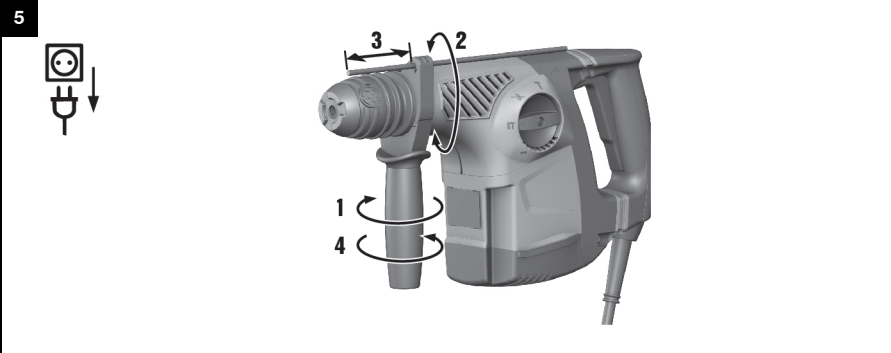
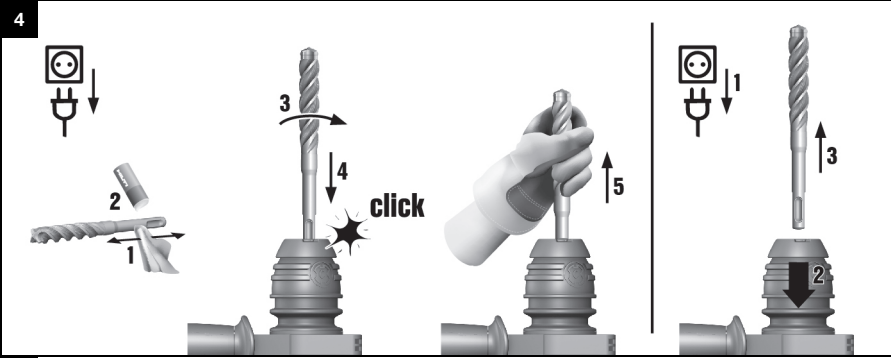
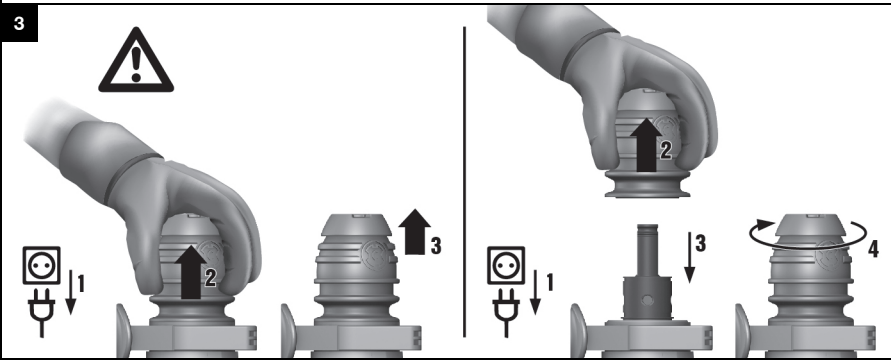
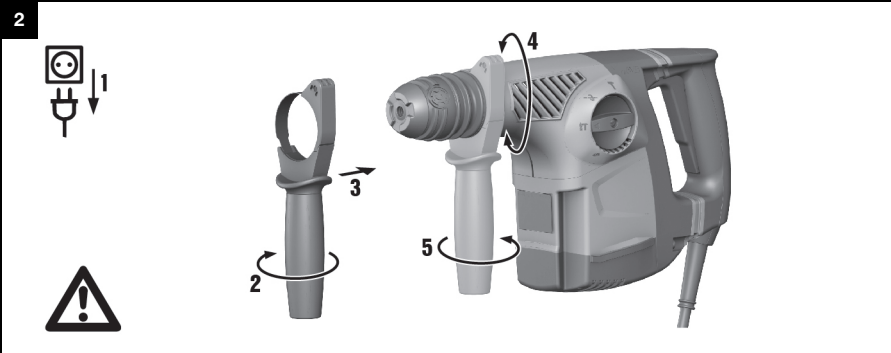

6

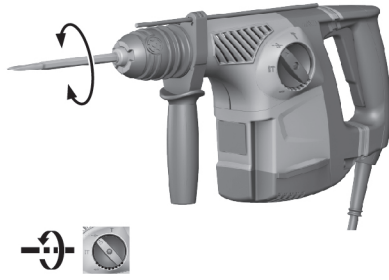
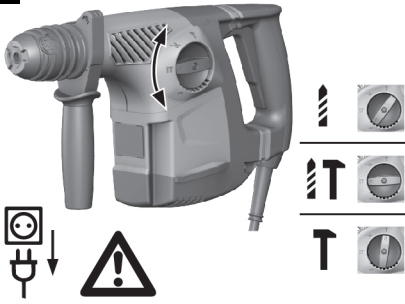

7



# TE 30

## TE 30-AVR

### TE 30-C-AVR



de	Original-Bedienungsanleitung	1
en	Original operating instructions	10
fr	Mode d'emploi original	19
it	Istruzioni originali	28
es	Manual de instrucciones original	37
pt	Manual de instruções original	46
nl	Originele handleiding	55
da	Original brugsanvisning	64
sv	Originalbruksanvisning	73
no	Original bruksanvisning	81
fi	Alkuperäiset ohjeet	89
el	Πρωτότυπες οδηγίες χρήσης	97
ar	دليل الاستعمال الأصلي	106
lv	Orģinālā lietošanas instrukcija	115
lt	Originali naudojimo instrukcija	124
et	Originaalkasutusjuhend	133

## 1 Information about the documentation

### 1.1 Explanation of signs used









#### 1.1.1 Warnings

Warnings alert persons to hazards that occur when handling or using the product. The following signal words are used in combination with a symbol:

	<b>DANGER!</b> Draws attention to imminent danger that will lead to serious personal injury or fatality.
	<b>WARNING!</b> Draws attention to a potential hazard that could lead to serious personal injury or fatality.
	<b>CAUTION!</b> Draws attention to a potentially dangerous situation that could lead to slight personal injury or damage to the equipment or other property.

#### 1.1.2 Symbols

The following symbols are used:

	Read the operating instructions before use.
	Instructions for use and other useful information
	Drilling without hammering
1 	Drilling without hammering, 1st gear
2 	Drilling without hammering, 2nd gear
	Drilling with hammering action (hammer drilling)
	Chiseling
	Chisel positioning
	Protection class II (double-insulated)
∅	Diameter
$n_0$	Rated speed under no load
/min	Revolutions per minute
RPM	Revolutions per minute

#### 1.1.3 Illustrations

The illustrations in these operating instructions are intended to promote a better understanding and may deviate from the actual version of the product.

<b>2</b>	These numbers refer to the corresponding illustrations found at the beginning of these operating instructions.
3	The numbering in the illustrations reflects the order of the work steps in the illustration and may deviate from the numbering of work steps in the text.
<b>11</b>	Item reference numbers are used in the overview illustration. In the product overview section, the numbers shown in the legend relate to these item reference numbers.

### 1.2 About this documentation

- ▶ Read these operating instructions before the product is used or operated for the first time. This is a prerequisite for safe, trouble-free handling and use of the product.
- ▶ Observe the safety instructions and warnings printed in this documentation and on the power tool.

- ▶ Always keep the operating instructions with the power tool and make sure that the operating instructions are with it when it is given to other persons.

We reserve the right to make changes. Errors excepted.

### 1.3 Product information

Hilti products are designed for professional use and may be operated, serviced and maintained only by trained, authorized personnel. This personnel must be informed of any particular hazards that may be encountered. The product and its ancillary equipment may present hazards when used incorrectly by untrained personnel or when used not as directed.

The type designation and serial number are printed on the type identification plate.

- ▶ Write down the serial number in the table below. You will be required to state the product details when contacting Hilti Service or your local Hilti organization to enquire about the product.

#### Product information

Combiammer	TE 30 / TE 30-AVR / TE 30-C-AVR
Generation	01
Serial no.	

We reserve the right to make changes. Errors excepted.

## 2 Safety

### 2.1 Safety instructions

The safety rules given in the following section contain all general safety rules for electric tools which, in accordance with the applicable standards, require to be listed in the operating instructions. Accordingly, some of the rules listed may not be relevant to this electric tool.

#### 2.1.1 General power tool safety warnings

##### WARNING

**Read all safety warnings and all instructions.** Failure to follow the warnings and instructions may result in electric shock, fire and/or serious injury.

**Save all warnings and instructions for future reference.**

The term "power tool" in the warnings refers to your mains-operated (corded) power tool or battery-operated (cordless) power tool.

##### Work area safety

- ▶ **Keep work area clean and well lit.** Cluttered or dark areas invite accidents.
- ▶ **Do not operate power tools in explosive atmospheres, such as in the presence of flammable liquids, gases or dust.** Power tools create sparks which may ignite the dust or fumes.
- ▶ **Keep children and bystanders away while operating a power tool.** Distractions can cause you to lose control.

##### Electrical safety

- ▶ **Power tool plugs must match the outlet. Never modify the plug in any way. Do not use any adapter plugs with earthed (grounded) power tools.** Unmodified plugs and matching outlets will reduce risk of electric shock.
- ▶ **Avoid body contact with earthed or grounded surfaces, such as pipes, radiators, ranges and refrigerators.** There is an increased risk of electric shock if your body is earthed or grounded.
- ▶ **Do not expose power tools to rain or wet conditions.** Water entering a power tool will increase the risk of electric shock.
- ▶ **Do not abuse the cord. Never use the cord for carrying, pulling or unplugging the power tool. Keep cord away from heat, oil, sharp edges or moving parts.** Damaged or entangled cords increase the risk of electric shock.
- ▶ **When operating a power tool outdoors, use an extension cord suitable for outdoor use.** Use of a cord suitable for outdoor use reduces the risk of electric shock.
- ▶ **If operating a power tool in a damp location is unavoidable, use a residual current device (RCD) protected supply.** Use of an RCD reduces the risk of electric shock.

## Personal safety

- ▶ **Stay alert, watch what you are doing and use common sense when operating a power tool. Do not use a power tool while you are tired or under the influence of drugs, alcohol or medication.** A moment of inattention while operating power tools may result in serious personal injury.
- ▶ **Use personal protective equipment. Always wear eye protection.** Protective equipment such as dust mask, non-skid safety shoes, hard hat, or hearing protection used for appropriate conditions will reduce personal injuries.
- ▶ **Prevent unintentional starting. Ensure the switch is in the off-position before connecting to power source and/or battery pack, picking up or carrying the tool.** Carrying power tools with your finger on the switch or energising power tools that have the switch on invites accidents.
- ▶ **Remove any adjusting key or wrench before turning the power tool on.** A wrench or a key left attached to a rotating part of the power tool may result in personal injury.
- ▶ **Do not overreach. Keep proper footing and balance at all times.** This enables better control of the power tool in unexpected situations.
- ▶ **Dress properly. Do not wear loose clothing or jewellery. Keep your hair, clothing and gloves away from moving parts.** Loose clothes, jewellery or long hair can be caught in moving parts.
- ▶ **If devices are provided for the connection of dust extraction and collection facilities, ensure these are connected and properly used.** Use of dust collection can reduce dust-related hazards.

## Power tool use and care

- ▶ Do not force the power tool. Use the correct power tool for your application. The correct power tool will do the job better and safer at the rate for which it was designed.
- ▶ **Do not use the power tool if the switch does not turn it on and off.** Any power tool that cannot be controlled with the switch is dangerous and must be repaired.
- ▶ **Disconnect the plug from the power source and/or the battery pack from the power tool before making any adjustments, changing accessories, or storing power tools.** Such preventive safety measures reduce the risk of starting the power tool accidentally.
- ▶ **Store idle power tools out of the reach of children and do not allow persons unfamiliar with the power tool or these instructions to operate the power tool.** Power tools are dangerous in the hands of untrained users.
- ▶ **Maintain power tools. Check for misalignment or binding of moving parts, breakage of parts and any other condition that may affect the power tool's operation. If damaged, have the power tool repaired before use.** Many accidents are caused by poorly maintained power tools.
- ▶ **Keep cutting tools sharp and clean.** Properly maintained cutting tools with sharp cutting edges are less likely to bind and are easier to control.
- ▶ **Use the power tool, accessories and tool bits etc. in accordance with these instructions, taking into account the working conditions and the work to be performed.** Use of the power tool for operations different from those intended could result in a hazardous situation.

## Service

- ▶ **Have your power tool serviced by a qualified repair person using only identical replacement parts.** This will ensure that the safety of the power tool is maintained.

### 2.1.2 Hammer safety warnings

- ▶ **Wear ear protectors.** Exposure to noise can cause hearing loss.
- ▶ **Use auxiliary handles, if supplied with the tool.** Loss of control can cause personal injury.
- ▶ **Hold power tool by insulated gripping surfaces, when performing an operation where the cutting accessory may contact hidden wiring or its own cord.** Cutting accessory contacting a "live" wire may make exposed metal parts of the power tool "live" and could give the operator an electric shock.

### 2.1.3 Additional safety instructions

#### Personal safety

- ▶ **Use the tool only when it is in technically faultless condition.**
- ▶ **Never tamper with or modify the tool in any way.**
- ▶ **Check that the side handle is fitted correctly and tightened securely.**
- ▶ **Always hold the power tool with both hands on the grips provided. Keep the grips dry, clean and free from oil and grease.**
- ▶ **Improve the blood circulation in your fingers by relaxing your hands and exercising your fingers during breaks between working.**
- ▶ **Avoid touching rotating parts. Switch the power tool on only after bringing it into position at the workpiece.** Touching rotating parts, especially rotating accessory tools, may lead to injury.



- ▶ **The tool is not intended for use by debilitated persons who have received no special training.**
- ▶ **Keep bystanders, children and visitors away while operating a power tool.**
- ▶ Dust from materials, such as paint containing lead, some wood species, concrete / masonry / stone containing silica, and minerals as well as metal, may be harmful. Contact with or inhalation of the dust may cause allergic reactions and/or respiratory or other diseases to the operator or bystanders. Certain kinds of dust are classified as carcinogenic such as oak and beech dust, especially in conjunction with additives for wood conditioning (chromate, wood preservative). Material containing asbestos may be handled only by specialists. **Use a dust removal system whenever possible. To achieve a high level of dust collection, use a suitable vacuum cleaner. When indicated, wear a respirator appropriate for the type of dust generated. Ensure that the workplace is well ventilated. Follow national requirements for the materials you want to work with.**
- ▶ **Before beginning the work, check the hazard classification of the dust that will be produced. Use an industrial vacuum cleaner with an officially approved protection classification in compliance with locally applicable dust protection regulations.**
- ▶ **Observe the national health and safety requirements.**

#### Electrical safety

- ▶ **Before beginning work, check the working area for concealed electric cables or gas and water pipes. External metal parts of the power tool may give you an electric shock if you damage an electric cable accidentally.**
- ▶ **Check the power tool's supply cord at regular intervals and have it replaced by a qualified specialist if found to be damaged. If the power tool's supply cord is damaged it must be replaced with a specially-prepared and approved supply cord available from Hilti Customer Service. Check extension cords at regular intervals and replace them if found to be damaged. Do not touch the supply cord or extension cord if it is damaged while working. Disconnect the supply cord plug from the power outlet. Damaged supply cords or extension cords present a risk of electric shock.**
- ▶ **Switch the electric tool off and unplug the supply cord in the event of an interruption in the electric supply in order to avoid inadvertent restarting when the power returns.**
- ▶ **Dirty or dusty power tools that have been used frequently for work on conductive materials should be checked at regular intervals at a Hilti Service Center. Dust (especially dust from conductive materials) or dampness adhering to the surface of the power tool may, under unfavorable conditions, lead to electric shock.**

#### Careful handling and use of power tools

- ▶ **Secure the workpiece. A workpiece clamped in a vice or secured by some other clamping device is more secure than when held only by hand.**
- ▶ **Switch the power tool off if the accessory tool sticks and stalls. The power tool may be deflected laterally.**
- ▶ **Wait until the power tool stops completely before you lay it down.**
- ▶ **Ensure that the accessory tools used have a mounting system that is compatible with the power tool and that they are secured in the chuck correctly.**
- ▶ **Wear protective gloves when changing accessory tools as they get hot during use.**

#### Work area

- ▶ **If the work involves breaking right through, take the appropriate safety measures at the opposite side. Parts breaking away could fall out and / or fall down and injure other persons.**

## 3 Description

### 3.1 Overview of the product

- |                                    |                                |
|------------------------------------|--------------------------------|
| ① Chuck                            | ⑤ Grip                         |
| ② Function selector switch         | ⑥ Supply cord                  |
| ③ Active Vibration Reduction (AVR) | ⑦ Forward / reverse switch     |
| ④ Control switch                   | ⑧ Side handle with depth gauge |

### 3.2 Intended use

The product described is an electrically powered combihammer. It is designed for drilling in concrete, masonry, wood and metal. The product can also be used for light to medium-duty chiseling on masonry and surface finishing work on concrete.

Under certain conditions, the product may also be suitable for stirring / mixing.

- ▶ Operation is permissible only when connected to a power source providing a voltage and frequency in compliance with the information given on the type identification plate.

### 3.3 Description of the device

#### 3.3.1 Active Vibration Reduction (AVR)

TE 30-AVR  
TE 30-C-AVR

The combihammer is equipped with an Active Vibration Reduction (AVR) system, which reduces vibration significantly.

#### 3.4 Items supplied

Rotary hammer, side handle, depth gauge, operating instructions.



#### Note

For safe, reliable operation, use only genuine Hilti spare parts and accessories. Spare parts, accessories and consumables approved by Hilti for use with this product can be found at your Hilti Center or at [www.hilti.com](http://www.hilti.com).

## 4 Technical data

### 4.1 Combihammer

When powered by a generator or transformer, the generator or transformer's power output must be at least twice the rated input power shown on the rating plate of the power tool. The operating voltage of the transformer or generator must always be within +5% and -15% of the rated voltage of the power tool.

The information given applies to a rated voltage of 230 V. The data may vary in the event of deviations from the rated voltage and for country-specific versions. Please refer to the power tool's rating plate for details of its voltage, frequency, current and input power ratings.

		Model		
		TE 30	TE 30-AVR	TE 30-C-AVR
Rated current input	230 V	4.0 A	4.0 A	4.0 A
Weight in accordance with EPTA procedure 01/2003		4.0 kg	4.2 kg	4.2 kg
Single impact energy in accordance with EPTA procedure 05/2009		3.3 J	3.3 J	3.3 J
Ø hammer drill bits		5 mm ... 28 mm	5 mm ... 28 mm	5 mm ... 28 mm
Ø drill bits for wood		5 mm ... 20 mm	5 mm ... 20 mm	5 mm ... 20 mm
Ø drill bits for metal		3 mm ... 13 mm	3 mm ... 13 mm	3 mm ... 13 mm

### 4.2 Noise information and vibration values determined in accordance with EN 60745

The sound pressure and vibration values given in these instructions have been measured in accordance with a standardized test and may be used to compare one electric tool with another. They may be used for a preliminary assessment of exposure. The data given represents the main applications of the electric tool. However, if the electric tool is used for different applications, with different accessory tools, or is poorly maintained, the data may vary. This may significantly increase exposure over the total working period. An accurate estimation of exposure should also take into account the times when the tool is switched off, or when it is running but not actually being used for a job. This may significantly reduce exposure over the total working period. Identify additional safety measures to protect the operator from the effects of noise and/or vibration, for example: maintenance of the electric tool and the accessories, keeping the hands warm, organization of work patterns.











Noise emission values determined in accordance with EN 60745-2-6

	TE 30	TE 30-AVR	TE 30-C-AVR
Sound (power) level ( $L_{WA}$ )	101 dB(A)	101 dB(A)	101 dB(A)
Uncertainty for the sound power level ( $K_{WA}$ )	3 dB(A)	3 dB(A)	3 dB(A)
Sound pressure level ( $L_{pA}$ )	90 dB(A)	90 dB(A)	90 dB(A)
Uncertainty for the sound pressure level ( $K_{pA}$ )	3 dB(A)	3 dB(A)	3 dB(A)

Total vibration (vector sum of three directions), measured in accordance with EN 60745-2-6

	TE 30	TE 30-AVR	TE 30-C-AVR
Hammer drilling in concrete ( $a_{h, HD}$ )	16.5 m/s <sup>2</sup>	12 m/s <sup>2</sup>	12 m/s <sup>2</sup>
Chiseling ( $a_{h, Cheq}$ )	•/•	•/•	11 m/s <sup>2</sup>
Uncertainty (K)	1.5 m/s <sup>2</sup>	1.5 m/s <sup>2</sup>	1.5 m/s <sup>2</sup>

## 5 Operation

<p><b>Fitting the side handle</b></p> <p> <b>CAUTION</b>  <b>Risk of injury</b> The depth gauge may hinder the operator if fitted but not used.</p> <ul style="list-style-type: none"> <li>▶ Remove the depth gauge from the tool.</li> </ul> <p> <b>CAUTION</b>  <b>Risk of injury!</b> Loss of control over the combihammer.</p> <ul style="list-style-type: none"> <li>▶ Check that the side handle is fitted correctly and tightened securely. Check that the clamping band is engaged in the groove provided on the tool.</li> </ul>	<b>2</b>
<p><b>Fitting / removing the chuck</b></p> <p> <b>CAUTION</b>  <b>Risk of injury</b> The depth gauge may hinder the operator if fitted but not used.</p> <ul style="list-style-type: none"> <li>▶ Remove the depth gauge from the tool.</li> </ul> <p> <b>Note</b>                      The function selector switch should be set to the <b>T</b> “Chiseling” position when changing the chuck.</p>	<b>3</b>
<p><b>Fitting / removing the accessory tool</b></p> <p> <b>Note</b>                      Use of unsuitable grease may cause damage to the product. <b>Use only the recommended grease supplied by Hilti.</b></p>	<b>4</b>
<b>Adjusting the depth gauge</b>	<b>5</b>
<b>Drilling without hammering</b> 	<b>6</b>
<b>Drilling with hammering action (hammer drilling)</b> 	<b>6</b>
TE 30-C-AVR	<b>6</b>
<p><b>Chisel positioning</b> </p> <p> <b>CAUTION</b>  <b>Risk of injury!</b> Loss of control over the chisel direction.</p> <ul style="list-style-type: none"> <li>▶ Do not operate the tool when the selector switch is set to “Chisel positioning”. Turn the function selector switch until it engages in the “Chiseling” position.</li> </ul> <p> <b>Note</b>                      The chisel can be adjusted to 12 different positions (in 30° increments). This ensures that flat chisels and shaped chisels can always be set to the optimum working position.</p>	<b>6</b>

TE 30-C-AVR	<b>6</b>
<b>Chiseling T</b>	
<b>Forward / reverse</b>	<b>7</b>
 <b>Note</b> Operate the forward / reverse selector switch only when the motor has stopped.	

## 6 Care of the product





 **WARNING**  
**Danger of electric shock!** Improper repairs to electrical components may lead to serious injuries including burns.

- ▶ Repairs to the electrical section of the tool or appliance may be carried out only by trained electrical specialists.

- ▶ **Keep the product, especially its grip surfaces, clean and free from oil and grease. Do not use cleaning agents containing silicone.**
- ▶ Never operate the product when the air vents are blocked. Clean the air vents carefully using a dry brush. Do not allow foreign objects to enter the interior of the product.
- ▶ Clean the outside of the electric tool at regular intervals with a slightly damp cloth. Do not use a spray, steam pressure cleaning equipment or running water for cleaning.

## 7 Troubleshooting

If the trouble you are experiencing is not listed in this table or you are unable to remedy the problem by yourself, please contact **Hilti Service**.

Trouble or fault	Possible cause	Action to be taken
The power tool doesn't start.	Interruption in the electric supply.	▶ Plug in another electric tool or appliance and check whether it works.
	The carbon brushes are worn out.	▶ Have the power tool checked by a trained electrical specialist and the carbon brushes replaced if necessary.
The tool cuts out while running.	Drilling for too long at low speed.	▶ Release the control switch and then press it again.
No hammering action.	The tool is too cold.	▶ Bring the tip of the drill bit into contact with the working surface, switch the rotary hammer on and allow it to run. If necessary, repeat the procedure until the hammering mechanism begins to operate.
	The function selector switch is set to "Rotary drilling only"  .	▶ Set the function selector switch to the "Hammer drilling" position  .
The combihammer doesn't achieve full power.	The gauge (cross section) of the extension cord conductors is inadequate.	▶ Use an extension cord with an adequate conductor cross section.
	The control switch is not fully pressed.	▶ Press the control switch as far as it will go.
The drill bit does not rotate.	The function selector switch is not engaged or is in the <b>T</b> "Chiseling" or  "Chisel adjustment" position.	▶ Set the function selector switch to "Drilling without hammering"  or "Hammer drilling"  .

Trouble or fault	Possible cause	Action to be taken
The drill bit cannot be released.	The chuck is not pulled back fully.	▶ Pull the chuck back as far as it will go and remove the accessory tool.
The drill bit makes no progress.	The tool has been set to reverse rotation.	▶ Set the tool to forward rotation.

## 8 Disposal

 Most of the materials from which **Hilti** tools and appliances are manufactured can be recycled. The materials must be correctly separated before they can be recycled. In many countries, your old tools, machines or appliances can be returned to **Hilti** for recycling. Ask **Hilti** Service or your Hilti representative for further information.

In accordance with the European Directive on waste electrical and electronic equipment and its implementation in conformance with national law, electric tools or appliances that have reached the end of their life must be collected separately and returned to an environmentally compatible recycling facility.



- 
- ▶ Disposal of electric tools or appliances together with household waste is not permissible.
- 

## 9 Manufacturer's warranty

- ▶ Please contact your local **Hilti** representative if you have questions about the warranty conditions.

## 10 EC declaration of conformity

### Manufacturer

Hilti Aktiengesellschaft  
 Feldkircherstrasse 100  
 9494 Schaan  
**Liechtenstein**

We declare, on our sole responsibility, that this product complies with the directives and standards listed below.

Designation Combihammer

Type designation TE 30

Generation 01

Year of design 2008

Type designation TE 30-AVR

Generation 01

Year of design 2008

Type designation TE 30-C-AVR

Generation 01

Year of design 2008

Applicable directives:

- 2004/108/EC (up to April 19, 2016)
- 2014/30/EU (as of April 20, 2016)
- 2006/42/EC
- 2011/65/EU

Applicable standards:

- EN 60745-1, EN 60745-2-6
- EN ISO 12100

Technical documentation filed at:

- Hilti Entwicklungsgesellschaft mbH

Zulassung Elektrowerkzeuge  
Hiltistraße 6  
86916 Kaufering  
**Germany**

Schaan, 5/2015



Paolo Luccini  
(Head of BA Quality & Process Management /  
Business Area Electric Tools & Accessories)



Tassilo Deinzer  
(Executive Vice President / Business Unit Power  
Tools & Accessories)



Hilti Corporation

LI-9494 Schaan

Tel.: +423/234 21 11

Fax: +423/234 29 65

[www.hilti.com](http://www.hilti.com)



402495