

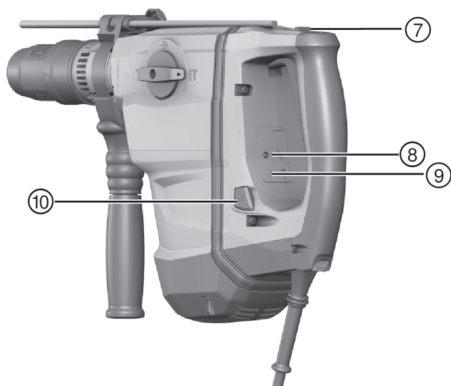

TE 60-AVR (04)  
TE 60-ATC/AVR (04)

English

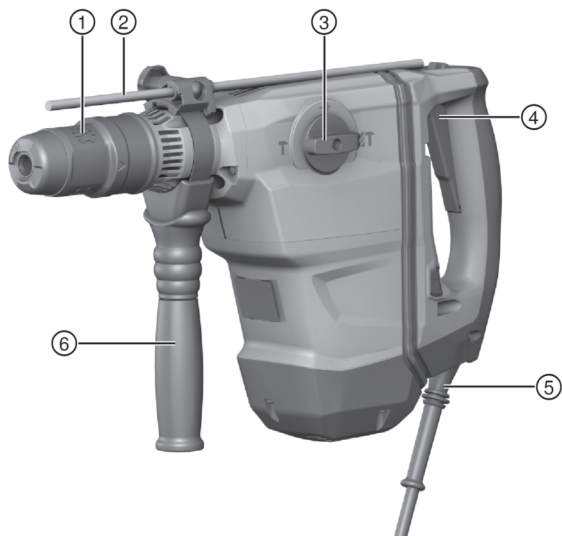



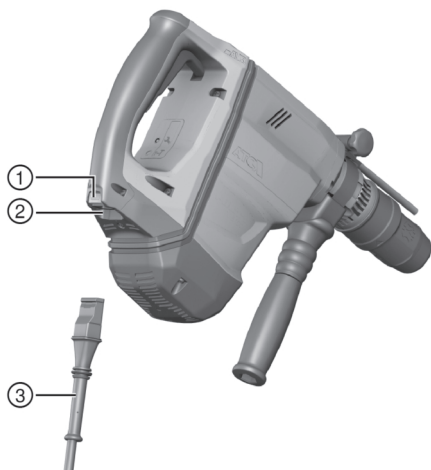

3

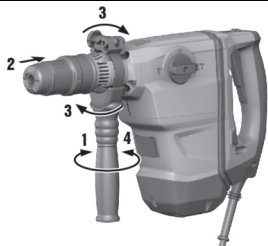
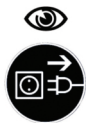

4

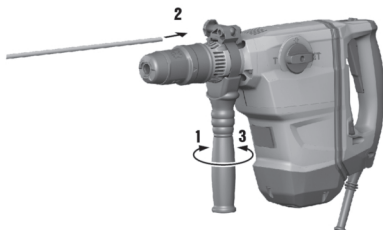

5

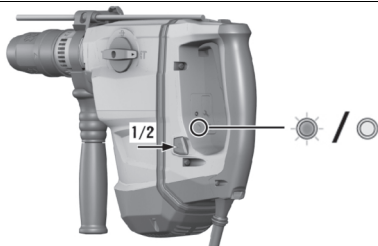

6

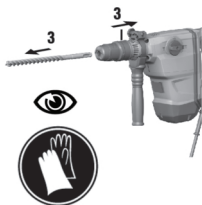
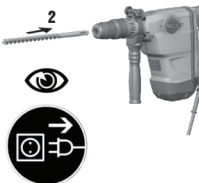

7

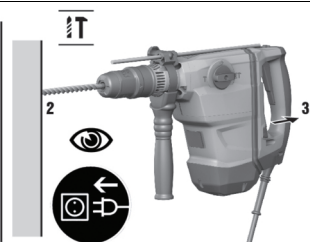
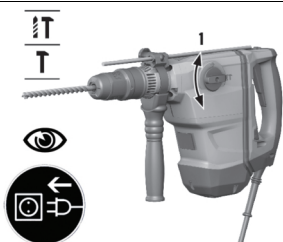

8

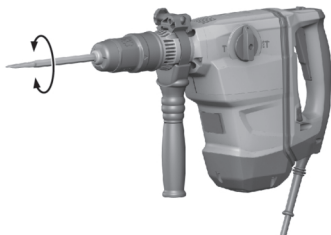

9

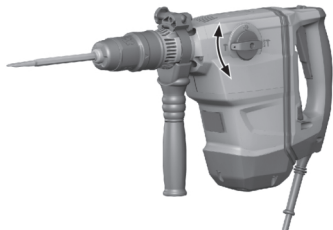

10



**en Original operating instructions****Information about the operating instructions****About these operating instructions**

- **Warning!** Read and understand all accompanying documentation, including but not limited to instructions, safety warnings, illustrations, and specifications provided with this product. Familiarize yourself with all the instructions, safety warnings, illustrations, specifications, components, and functions of the product before use. Failure to do so may result in electric shock, fire, and/or serious injury. Save all warnings and instructions for future reference.
- **HILTI** products are designed for professional users and only trained, authorized personnel are permitted to operate, service and maintain the products. This personnel must be specifically informed about the possible hazards. The product and its ancillary equipment can present hazards if used incorrectly by untrained personnel or if used not in accordance with the intended use.
- The accompanying documentation corresponds to the current state of the art at the time of printing. Please always check for the latest version on the product's page on Hilti's website. To do this, follow the link or scan the QR code in this documentation, marked with the symbol .
- Ensure that these operating instructions are with the product when it is given to other persons.

**Explanation of symbols****Warnings**

Warnings alert persons to hazards that occur when handling or using the product. The following signal words are used:

 **DANGER**

**DANGER !**

- ▶ Draws attention to imminent danger that will lead to serious personal injury or fatality.

 **WARNING**

**WARNING !**

- ▶ Draws attention to a potential threat of danger that can lead to serious injury or fatality.





 **CAUTION**

**CAUTION !**

- ▶ Draws attention to a potentially dangerous situation that could lead to personal injury or damage to the equipment or other property.

**Symbols in the operating instructions**

The following symbols are used in these operating instructions:

	Comply with the operating instructions
	Instructions for use and other useful information
	Dealing with recyclable materials
	Do not dispose of electric equipment and batteries as household waste

**Symbols in illustrations**

The following symbols are used in illustrations:

<b>2</b>	These numbers refer to the illustrations at the beginning of these operating instructions.
3	The numbers in illustrations refer to important work steps or to components important for the work steps. In the text, the corresponding numbers draw attention to these work steps or components, e.g. <b>(3)</b> .





⑪	Item reference numbers are used in the <b>overview illustration</b> and refer to the numbers used in the key in the <b>product overview</b> section.
	This symbol is intended to draw your special attention to certain points for handling the product.

## Product-dependent symbols

### Symbols on the product

The following symbols are used on the product:

	Drilling without hammering action
	Drilling with hammering action (hammer drilling)
	Chiseling
	Chisel positioning
	Forward / reverse
	Protection class II (double-insulated)
	Protective earth / ground (only TE 60-AVR)
	Diameter
$n_0$	Rated speed under no load
/min	Revolutions per minute

## Safety

### General power tool safety warnings

**⚠ WARNING** Read all safety warnings, instructions, illustrations and specifications provided with this power tool. Failure to follow all instructions listed below may result in electric shock, fire and/or serious injury.

**Save all warnings and instructions for future reference.**

The term "power tool" in the warnings refers to your mains-operated (corded) power tool or battery-operated (cordless) power tool.

### Work area safety

- ▶ **Keep work area clean and well lit.** Cluttered or dark areas invite accidents.
- ▶ **Do not operate power tools in explosive atmospheres, such as in the presence of flammable liquids, gases or dust.** Power tools create sparks which may ignite the dust or fumes.
- ▶ **Keep children and bystanders away while operating a power tool.** Distractions can cause you to lose control.

### Electrical safety

- ▶ **Power tool plugs must match the outlet. Never modify the plug in any way. Do not use any adapter plugs with earthed (grounded) power tools.** Unmodified plugs and matching outlets will reduce risk of electric shock.
- ▶ **Avoid body contact with earthed or grounded surfaces, such as pipes, radiators, ranges and refrigerators.** There is an increased risk of electric shock if your body is earthed or grounded.
- ▶ **Do not expose power tools to rain or wet conditions.** Water entering a power tool will increase the risk of electric shock.
- ▶ **Do not abuse the cord. Never use the cord for carrying, pulling or unplugging the power tool. Keep cord away from heat, oil, sharp edges or moving parts.** Damaged or entangled cords increase the risk of electric shock.



- ▶ **When operating a power tool outdoors, use an extension cord suitable for outdoor use.** Use of a cord suitable for outdoor use reduces the risk of electric shock.
- ▶ **If operating a power tool in a damp location is unavoidable, use a residual current device (RCD) protected supply.** Use of an RCD reduces the risk of electric shock.

#### **Personal safety**

- ▶ **Stay alert, watch what you are doing and use common sense when operating a power tool. Do not use a power tool while you are tired or under the influence of drugs, alcohol or medication.** A moment of inattention while operating power tools may result in serious personal injury.
- ▶ **Use personal protective equipment. Always wear eye protection.** Protective equipment such as a dust mask, non-skid safety shoes, hard hat or hearing protection used for appropriate conditions will reduce personal injuries.
- ▶ **Prevent unintentional starting. Ensure the switch is in the off-position before connecting to power source and/or battery pack, picking up or carrying the tool.** Carrying power tools with your finger on the switch or energising power tools that have the switch on invites accidents.
- ▶ **Remove any adjusting key or wrench before turning the power tool on.** A wrench or a key left attached to a rotating part of the power tool may result in personal injury.
- ▶ **Do not overreach. Keep proper footing and balance at all times.** This enables better control of the power tool in unexpected situations.
- ▶ **Dress properly. Do not wear loose clothing or jewellery. Keep your hair and clothing away from moving parts.** Loose clothes, jewellery or long hair can be caught in moving parts.
- ▶ **If devices are provided for the connection of dust extraction and collection facilities, ensure these are connected and properly used.** Use of dust collection can reduce dust-related hazards.
- ▶ **Do not let familiarity gained from frequent use of tools allow you to become complacent and ignore tool safety principles.** A careless action can cause severe injury within a fraction of a second.

#### **Power tool use and care**

- ▶ **Do not force the power tool. Use the correct power tool for your application.** The correct power tool will do the job better and safer at the rate for which it was designed.
- ▶ **Do not use the power tool if the switch does not turn it on and off.** Any power tool that cannot be controlled with the switch is dangerous and must be repaired.
- ▶ **Disconnect the plug from the power source and/or remove the battery pack, if detachable, from the power tool before making any adjustments, changing accessories, or storing power tools.** Such preventive safety measures reduce the risk of starting the power tool accidentally.
- ▶ **Store idle power tools out of the reach of children and do not allow persons unfamiliar with the power tool or these instructions to operate the power tool.** Power tools are dangerous in the hands of untrained users.
- ▶ **Maintain power tools and accessories. Check for misalignment or binding of moving parts, breakage of parts and any other condition that may affect the power tool's operation. If damaged, have the power tool repaired before use.** Many accidents are caused by poorly maintained power tools.
- ▶ **Keep cutting tools sharp and clean.** Properly maintained cutting tools with sharp cutting edges are less likely to bind and are easier to control.
- ▶ **Use the power tool, accessories and tool bits etc. in accordance with these instructions, taking into account the working conditions and the work to be performed.** Use of the power tool for operations different from those intended could result in a hazardous situation.
- ▶ **Keep handles and grasping surfaces dry, clean and free from oil and grease.** Slippery handles and grasping surfaces do not allow for safe handling and control of the tool in unexpected situations.



## Service

- ▶ **Have your power tool serviced by a qualified repair person using only identical replacement parts.** This will ensure that the safety of the power tool is maintained.

## Hammer safety warnings

### Safety instructions for all operations

- ▶ **Wear ear protectors.** Exposure to noise can cause hearing loss.
- ▶ **Use auxiliary handle(s), if supplied with the tool.** Loss of control can cause personal injury.
- ▶ **Hold the power tool by insulated gripping surfaces, when performing an operation where the cutting accessory may contact hidden wiring or its own cord.** Cutting accessory contacting a "live" wire may make exposed metal parts of the power tool "live" and could give the operator an electric shock.

### Safety instructions when using long drill bits with rotary hammers

- ▶ **Always start drilling at low speed and with the bit tip in contact with the workpiece.** At higher speeds, the bit is likely to bend if allowed to rotate freely without contacting the workpiece, resulting in personal injury.
- ▶ **Apply pressure only in direct line with the bit and do not apply excessive pressure.** Bits can bend causing breakage or loss of control, resulting in personal injury.

## Additional safety instructions for rotary hammer drill

### Personal safety

- ▶ Use the product and accessories only when they are in perfect working order.
- ▶ Never tamper with or modify the product or accessories in any way.
- ▶ Use auxiliary handles supplied with the product. Loss of control can cause personal injury.
- ▶ Apply appropriate safety measures at the opposite side of the workpiece in work that involves breaking through. Parts breaking away could fall out and / or fall down causing injury to other persons.
- ▶ Always hold the tool with both hands on the grips provided. Keep the grips clean and dry.
- ▶ Hold the product by the insulated gripping surfaces when performing work in which the accessory tool might come into contact with concealed wiring. If the accessory tool comes into contact with a live wire, metal parts of the power tool can also become live, resulting in an electric shock.
- ▶ Do not touch rotating parts – risk of injury!
- ▶ Wear eye protection, a hard hat and ear protection and suitable respiratory protection while the product is in use.
- ▶ Wear protective gloves when changing the accessory tool. Touching the accessory tool can result in cuts and burns.
- ▶ Wear eye protection. Flying fragments can injure the body and eyes.
- ▶ Dust produced by grinding, sanding, cutting and drilling can contain dangerous chemicals. Some examples are: lead or lead-based paints; brick, concrete and other masonry products, natural stone and other products containing silicates; certain types of wood, such as oak, beech and chemically treated wood; asbestos or materials that contain asbestos. Determine the exposure of the operator and bystanders by means of the hazard classification of the materials to be worked. Implement the necessary measures to restrict exposure to a safe level, for example by the use of a dust collection system or by the wearing of suitable respiratory protection. The general measures for reducing exposure include:
  - ▶ working in an area that is well ventilated,
  - ▶ avoidance of prolonged contact with dust,
  - ▶ directing dust away from the face and body,
  - ▶ wearing protective clothing and washing exposed areas of the skin with water and soap.



- ▶ Take frequent breaks and do physical exercises to improve the blood circulation in your fingers. High vibration during long periods of work can lead to disorders of the blood vessels and nervous system in the fingers, hands and wrists.

### Electrical safety

- ▶ Before beginning work, check the working area for concealed electric cables or gas and water pipes. External metal parts of the product could give you an electric shock or cause an explosion if you accidentally damage an electric cable or a gas or water pipe.

### Power tool use and care

- ▶ Switch the product off immediately if the accessory tool jams. The product might twist off-line.
- ▶ Wait until the product has come to a complete stop before you lay it down.

---

## Description

### Overview of the product 1

- |                            |                                       |
|----------------------------|---------------------------------------|
| ① Chuck                    | ⑥ Side handle                         |
| ② Depth gauge              | ⑦ Lockbutton for continuous operation |
| ③ Function selector switch | ⑧ Service indicator                   |
| ④ Control switch           | ⑨ Reduced-power indicator             |
| ⑤ Supply cord              | ⑩ Power reduction button (50% power)  |

### Version with detachable supply cord 2

- |                              |   |
|------------------------------|---|
| ① Lockbutton                 | ③ Supply cord with keyed, releasable plug connector |
| ② Connector on electric tool |   |

### Intended use

The product described is an electrically powered combihammer with pneumatic hammering mechanism. It is designed for drilling in concrete, masonry, wood and metal. The product can also be used for light- to medium-duty chiseling on masonry and surface finishing work on concrete.

- ▶ The tool may be operated only when connected to a power source providing a voltage and frequency in compliance with the information given on the type identification plate.

### Possible misuse

- This product is not suitable for working on hazardous materials.
- This product is not suitable for working in a damp environment.

### Undercut anchors

The product is suitable for setting undercut anchors. Use only suitable setting tools.

Detailed information on this topic can be obtained at your local **Hilti** Center.

### ATC

The product is equipped with the ATC (Active Torque Control) quick-acting electronic cut-out.

If the accessory tool sticks or stalls, the product will suddenly pivot about its own axis in the opposite direction. ATC detects this sudden pivoting movement of the product and switches the product off immediately.

- 
-  For ATC to function correctly, the product must be free to pivot. After an ATC cut-out, switch the product off and then on again.

### Active Vibration Reduction

The tool is equipped with an Active Vibration Reduction (AVR) system which reduces vibration noticeably.



### Quick-release chuck (accessory)

The quick-release chuck makes changing accessory tools a quick operation with no additional tools needed. It is suitable for accessory tools with cylindrical or hexagonal shank used in the "Without hammering action " mode.

### Service indicator

The product is equipped with a service indicator LED.

### Service indicator status

Status	Meaning
The service indicator lights.	End of service interval – servicing is due.
The service indicator blinks.	Have the combihammer repaired by <b>Hilti Service</b> .

### Items supplied

Combihammer, side handle, operating instructions.

### Technical data

#### Combihammer

When powered by a generator or transformer, the generator or transformer's power output must be at least twice the rated input power shown on the rating plate of the power tool. The operating voltage of the transformer or generator must always be within +5% and -15% of the rated voltage of the power tool.

The information given applies to a rated voltage of 230 V. The data may vary in the event of deviations from the rated voltage and for country-specific versions. Please refer to the power tool's rating plate for details of its voltage, frequency, current and input power ratings.

	TE 60-AVR	TE 60-ATC/AVR
<b>Product generation</b>	04	04
<b>Rated power input</b>	1,350 W	1,350 W
<b>Rated current input</b>	7.2 A	7.2 A
<b>Weight in accordance with EPTA procedure 01/2003</b>	6.8 kg	7.8 kg
<b>Single impact energy in accordance with EPTA procedure 05</b>	7.8 J	7.8 J
<b>Hammer drill bits, Ø</b>	12 mm ... 55 mm	12 mm ... 55 mm
<b>Ø Breach bits</b>	40 mm ... 80 mm	40 mm ... 80 mm
<b>Ø Percussion core bits</b>	45 mm ... 100 mm	45 mm ... 100 mm
<b>Ø PCM diamond core bits</b>	*/•	42 mm ... 102 mm
<b>Ø drill bits for metal</b>	10 mm ... 20 mm	10 mm ... 20 mm
<b>Ø Drill bits for wood</b>	10 mm ... 32 mm	10 mm ... 32 mm
<b>Chuck</b>	TE-Y	TE-Y

### Noise information and vibration values



The sound pressure and vibration values given in these instructions were measured in accordance with a standardized test and can be used to compare one power tool with another. They can also be used for a preliminary assessment of exposure.

The data given represent the main applications of the power tool. However, if the power tool is used for different applications, with different accessory tools, or is poorly maintained, the data can vary. This can significantly increase exposure over the total working period.



An accurate estimation of exposure should also take into account the times when the power tool is switched off, or when it is running but not actually being used for a job. This can significantly reduce exposure over the total working period.

Identify additional safety measures to protect the operator from the effects of noise and/or vibration, for example: maintaining the power tool and accessory tools, keeping the hands warm, organization of work patterns.

 Detailed information on the versions of the **EN 62841** standards applied here is to be found in the reproduction of the declaration of conformity  12.

### Noise information

	TE 60-AVR	TE 60-ATC/AVR
Sound power level ( $L_{WA}$ )	107 dB(A)	111 dB(A)
Uncertainty for the sound power level ( $K_{WA}$ )	3 dB(A)	3 dB(A)
Sound pressure level ( $L_{pA}$ )	99 dB(A)	103 dB(A)
Uncertainty for the sound pressure level ( $K_{pA}$ )	3 dB(A)	3 dB(A)

### Total vibration

	TE 60-AVR	TE 60-ATC/AVR
Hammer drilling in concrete ( $a_{h, HD}$ )	10.5 m/s <sup>2</sup>	7.2 m/s <sup>2</sup>
Chiseling ( $a_{h, Cheq}$ )	9.1 m/s <sup>2</sup>	6.2 m/s <sup>2</sup>
Uncertainty (total vibration)	1.5 m/s <sup>2</sup>	1.5 m/s <sup>2</sup>

### Operation

#### Preparations at the workplace

#### CAUTION

**Risk of injury!** Inadvertent starting of the product.

- ▶ Unplug the supply cord before making adjustments to the power tool or before changing accessories.

Observe the safety instructions and warnings in this documentation and on the product.

#### Fitting the side handle

1. Release the side handle clamping band by turning the handle grip.
2. Slide the side handle clamping band over the tool holder from the front and into the recess provided.
3. Bring the side handle into the desired position.
4. Tighten the side handle clamping band by turning the handle grip.

#### Fitting the depth gauge (optional)

1. Release the side handle clamping band by turning the handle grip.
2. Slide the depth gauge from the front into the 2 guide holes provided.
3. Tighten the side handle clamping band by turning the handle grip.

#### Setting the power level (optional)

TE 60-ATC/AVR

 After the supply cord is connected to the AC supply, the product is always set by default to full power.

1. Press the power reduction button. The product runs at reduced power (50 %).
  - ▶ The reduced-power LED lights.
2. Press the power reduction button again. The product runs at full power.
  - ▶ The reduced-power LED goes out.



**Fitting the accessory tool 6**

1. Apply a little grease to the connection end of the accessory tool.

- ▶ Use only genuine **Hilti** grease. Using the wrong grease can result in damage to the product.

2. Push the accessory tool into the tool holder as far as it will go (until it engages).

3. After fitting the accessory tool, grip it and pull it in order to check that it is securely engaged.

- ▶ The product is ready for use.

**Removing the accessory tool 6****⚠ CAUTION**

**Risk of injury by the accessory tool!** The accessory tool might be hot or have sharp edges.

- ▶ Wear protective gloves when changing the accessory tool.

▶ Pull the tool lock back as far as it will go and remove the accessory tool.

**Types of work****⚠ CAUTION**

**Risk of injury** Loss of control over the product.

- ▶ Check that the side handle is fitted correctly and tightened securely. Check that the clamping band is engaged in the groove in the product.

Observe the safety instructions and warnings in this documentation and on the product.

**Drilling with hammering action (hammer drilling) 7**

1. Set the function selector switch to this symbol: .

2. Set the desired power level.

3. Press the drill bit against the work surface.

4. Press the control switch.

- ▶ The product starts.

**Drilling without hammering**

**i** Drilling without hammering action is possible when accessory tools with a special connection end are used. Accessory tools of this kind are available from **Hilti**. Alternatively, when the keyless quick-release chuck is fitted, smooth-shank drill bits for wood or steel, for example, can be used to drill without hammering.

- ▶ Set the function selector switch to this symbol: .

**Chisel positioning 8****⚠ CAUTION**

**Risk of injury!** Loss of control over the chisel direction.

- ▶ Do not operate the tool when the selector switch is set to “Chisel positioning”. Turn the function selector switch until it engages in the “Chiseling” position.

**i** The chisel can be adjusted to 24 different positions (in 15° increments). This ensures that flat chisels and shaped chisels can always be set to the optimum working position.

1. Set the function selector switch to this symbol: .

2. Rotate the chisel to the desired position.

3. Set the function selector switch to this symbol:  until it engages.

- ▶ The product is ready for use.

**Chiseling 9**

- ▶ Set the function selector switch to this symbol: .



**Switch sustained operation on and off 10**

**i** When chiseling, the control switch can be locked in the “on” position.

1. Push the lockbutton for continuous operation forward.
2. Press the control switch fully.
  - ▶ The product then runs in sustained operating mode.
3. Push the lockbutton for continuous operation back.
  - ▶ The product switches off.

**Care and maintenance****⚠ WARNING**

**Electric shock hazard!** Attempting care and maintenance with the supply cord connected to a power outlet can lead to severe injury and burns.

- ▶ Always unplug the supply cord before carrying out care and maintenance tasks.

**Care**

- Carefully remove stubborn dirt from the tool.
- Clean the air vents carefully with a dry brush.
- Use only a slightly damp cloth to clean the casing. Do not use cleaning agents containing silicone as they can attack the plastic parts.

**Maintenance****⚠ WARNING**

**Danger of electric shock!** Improper repairs to electrical components may lead to serious injuries including burns.

- ▶ Repairs to the electrical section of the tool or appliance may be carried out only by trained electrical specialists.
- Check all visible parts and controls for signs of damage at regular intervals and make sure that they all function correctly.
  - Do not operate the product if signs of damage are found or if parts malfunction. Have it repaired immediately by **Hilti Service**.
  - After cleaning and maintenance, fit all guards or protective devices and check that they function correctly.

**i** To help ensure safe and reliable operation, use only genuine Hilti spare parts and consumables. Spare parts, consumables and accessories approved by Hilti for use with the product can be found at your local **Hilti Store** or online at: [www.hilti.group](http://www.hilti.group).

**Connecting the detachable supply cord****⚠ CAUTION**

**Risk of injury!** Due to leakage current as a result of dirty contacts.

- ▶ Connect the detachable electric connector to the electric tool only when it is clean and dry and when the supply cord is unplugged from the power outlet.

1. Push the keyed, detachable electric plug connector into the tool as far as it will go, until it is heard to engage.
2. Plug the supply cord into the power outlet.

**Disconnecting the detachable supply cord**

1. Unplug the supply cord from the power outlet.
2. Press the release button and pull the keyed, detachable electric plug connector out of the socket.
3. Pull the supply cord connector out of the power tool.







## Transport and storage

- Do not transport electric tools with accessory tools fitted.
- Always unplug the supply cord before storing an electric tool or appliance.
- Store tools and appliances in a dry place where they cannot be accessed by children or unauthorized persons.
- Check electric tools or appliances for damage after long periods of transport or storage.

## Troubleshooting

If the trouble you are experiencing is not listed in this table or you are unable to remedy the problem by yourself, please contact **Hilti Service**.

Trouble or fault	Possible cause	Action to be taken
No hammering action.	The product is too cold.	▶ Bring the tip of the accessory tool into contact with the working surface, switch the power tool on and allow it to run. If necessary, repeat the procedure until the hammering mechanism begins to operate.
Product does not develop full power.	The extension cord is too long and/or its gauge is inadequate.	▶ Use an extension cord of an approved length and/or of adequate gauge.
	The control switch is not fully pressed.	▶ Press the control switch as far as it will go.
	The voltage provided by the electric supply is too low.	▶ Connect the combihammer to a different electric supply.
	The reduced-power (50% power) button is engaged.	▶ Press the reduced-power button.
The drill bit does not rotate.	The function selector switch is not correctly engaged, is set to "Chiseling"  , or is set to "Chisel positioning"  .	▶ Move the function selector switch to the "Hammer drilling"  position while the motor is not rotating.
The drill bit cannot be released.	The chuck is not pulled back fully.	▶ Pull the tool lock back as far as it will go and remove the accessory tool.
	The side handle is not fitted correctly.	▶ Release the side handle and refit it correctly so that the clamping band and side handle engage in the recess.
Product does not start.	Interruption in the electric supply.	▶ Plug in another electric tool or appliance and check whether it works.
	The electronic restart interlock is activated after an interruption in the electric supply.	▶ Switch the product off and then on again.
	The supply cord or plug is defective.	▶ Have the supply cord or the plug checked by a trained electrical specialist and replaced if necessary.



Trouble or fault	Possible cause	Action to be taken
Product does not start.	The detachable supply cord is not fitted correctly.	▶ Fit the detachable supply cord to the power tool correctly.
	Generator with sleep mode.	▶ Apply a load to the generator by connecting a second power consumer (e.g. worklight). After this, switch the product off and then on again.
The service indicator lights.	The carbon brushes are worn.	▶ Have the product checked by a trained electrical specialist; have the carbon brushes replaced, if necessary.
The service indicator blinks.	Damage to the product or service limit time reached.	▶ Have the product repaired by <b>Hilti Service</b> .

### Disposal

Most of the materials from which **Hilti** tools and appliances are manufactured can be recycled. The materials must be correctly separated before they can be recycled. In many countries, your old tools, machines or appliances can be returned to **Hilti** for recycling. Ask **Hilti Service** or your Hilti representative for further information.



▶ Do not dispose of power tools, electronic equipment or batteries as household waste!

### Manufacturer's warranty

▶ Please contact your local **Hilti** representative if you have questions about the warranty conditions.





## Declaration of conformity

### Declaration of conformity

The manufacturer declares, on his sole responsibility, that the product described here complies with the applicable legislation and standards.

The technical documentation is filed here:

Hilti Entwicklungsgesellschaft mbH | Tool Certification | Hiltistrasse 6 | D-86916 Kaufering, Germany

### Product information

Combihammer	TE 60-AVR   TE 60-ATC/AVR
Generation	04
Serial no.	1-99999999999

#### Hilti Corporation

Feldkircherstraße 100  
9494 Schaan | Liechtenstein

#### TE 60 (04) | TE 60-AVR (04) | TE 60-ATC/AVR (04)

2006/42/EC

EN 62841-1:2015, AC:2015,

EN IEC 62841-2-6:2020/A11:2020

2014/30/EU

A11:2022

EN IEC 55014-2:2021

2011/65/EU

EN IEC 55014-1:2021

EN 61000-3-3:2013, A1:2019,

EN IEC 61000-3-2:2019, A1:2021

A2:2021, A2:2021/AC:2022



Schaan, 29.03.2024



**Dr. Tahar Zrilli**

Head of Quality and Process Management  
Business Area Electric Tools & Accessories



**Edward-Louis Przybylowicz**

Head of BU Power Tool & Accessories  
Business Area Electric Tools & Accessories



2134960

**UK Declaration of Conformity****Declaration of conformity**

The manufacturer declares, on his sole responsibility, that the product described here complies with the applicable legislation and standards.

The technical documentation is filed here:

Hilti Entwicklungsgesellschaft mbH | Tool Certification | Hiltistrasse 6 | D-86916 Kaufering, Germany

**Product information**

Combihammer	TE 60-AVR   TE 60-ATC/AVR
Generation	04
Serial no.	1-9999999999

**Manufacturer:**

Hilti Corporation  
Feldkirchenstraße 100  
9494 Schaan | Liechtenstein

**UK Importer:**

Hilti (Gt. Britain) Limited  
No. 1 Circle Square, 3 Symphony Park  
Manchester, England, M1 7FS

**TE 60 (04) | TE 60-AVR (04) | TE 60-ATC/AVR (04)**

Supply of Machinery (Safety) Regulations  
2008

EN 62841-1:2015, AC:2015,  
A11:2022

EN IEC 62841-2-6:2020/A11:2020  
EN IEC 55014-2:2021

Electromagnetic Compatibility Regulations  
2016

EN IEC 55014-1:2021

EN 61000-3-3:2013, A1:2019,

The Restriction of the Use of Certain  
Hazardous Substances in Electrical and  
Electronic Equipment Regulations 2012

EN IEC 61000-3-2:2019, A1:2021

A2:2021, A2:2021/AC:2022

Schaan, 29.03.2024

**Dr. Tahar Zrilli**

Head of Quality and Process Management  
Business Area Electric Tools & Accessories

**Edward-Louis Przybyłowicz**

Head of BU Power Tool & Accessories  
Business Area Electric Tools & Accessories











Hilti Corporation  
LI-9494 Schaan  
Tel.:+423 234 21 11  
Fax:+423 234 29 65  
[www.hilti.group](http://www.hilti.group)



2134960